

ENGLISH
WOLFVISION®

VZ-8plus³
VZ-8light³



VZ-8 Series
3rd Edition

Number 1 in Quality, Innovation and Ease of Use

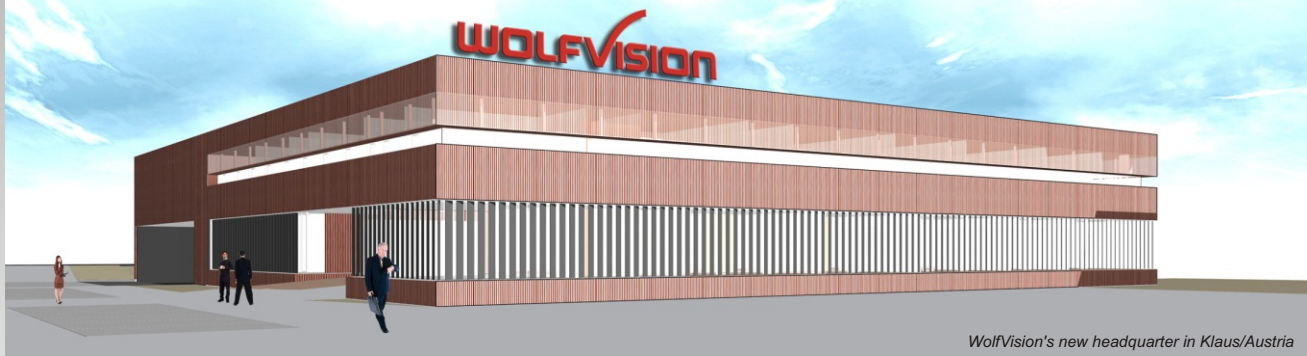

WolfVision's new headquarter in Klaus/Austria



WolfVision is a worldwide successful family owned company, based in Austria/Europe. Being a typical European high tech company, the focus is clearly on quality and innovation.

With 10% of the turnover invested in research and development, WolfVision has been holding its position as the "Technology Leader" in the Visualizer market since the early 90s. WolfVision is the company that sets the worldwide standards of product quality, innovation and ease of use.

Even though the great majority of WolfVision units never need any servicing, WolfVision also gives high priority to fast and uncomplicated service and support.

WolfVision's high quality standards are visible throughout the whole company. From research and development to purchasing, manufacturing, quality control, sales and support.

WOLFVISION Mechanical Quality

Mechanical quality is a basic requirement for all WolfVision products. WolfVision units are solid and can hardly be damaged. They are built to last a very long lifetime.

If you want to check out the difference in mechanical stability and reliability between a WolfVision Visualizer and any other document camera on the market, just "touch" the units. You will immediately "feel" the difference.

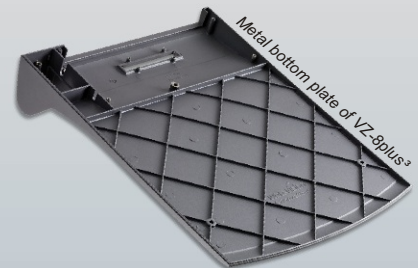

5 Elements of WOLFVISION Picture Quality

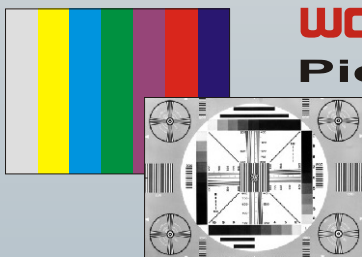

WolfVision Visualizers have always been famous for their outstanding picture quality, which is due to a perfect mixture of high end components and remarkable know-how.

The picture quality of a Visualizer or camera can only be as good as its weakest component. The following 5 basic elements are responsible for perfect picture quality, as found on all WolfVision units:



Camera Lens

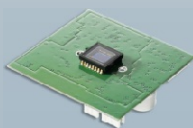

+ Image Sensor (CCD)



+ Electronic Hardware



+ Software (Firmware)



+ Light System

Perfect picture quality means high resolution throughout the whole picture (including the edges), lifelike colors, high frame rate, fast and precise auto focus, smooth zooming, an overall distortion free picture, even lighting without reflections or hot spots and much more.

WolfVision's high priority on perfect picture quality can be seen throughout the whole product line - from the entry level to the top of the line Visualizers.

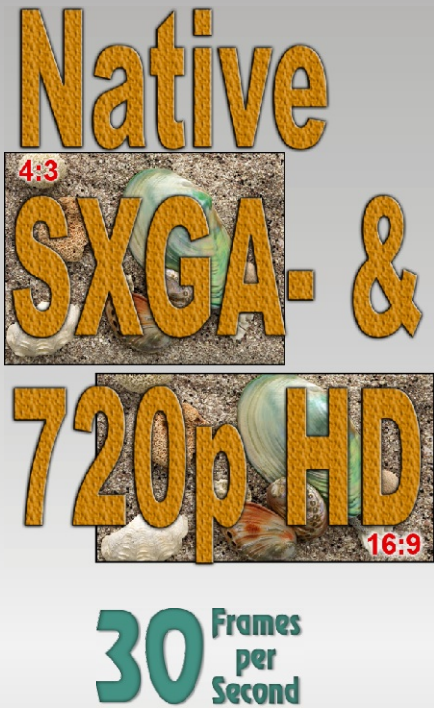

Extremely High Resolution SXGA- / 720p HD

The most important new feature of the "third generation" of VZ-8 Visualizers is the upgrade to a higher resolution CCD camera with 1280 x 960 pixels and 30 frames per second. This is native SXGA- resolution with an aspect ratio of 4:3.

The camera also outputs native 720p HD (High Definition) with 1280 x 720 pixels at a widescreen aspect ratio of 16:9.

The VZ-8plus³ and VZ-8light³ offer 750 lines of resolution. Naturally these 750 lines are visible in every part of the picture, including the edges, as WolfVision only uses high-end lenses.

Besides the native image formats SXGA- and 720p HD, both Visualizers can also output the image scaled to XGA and WXGA. The quality of the scaling is exceptional. The signal is better than with an original XGA or WXGA camera.

Additional image formats of the Visualizer VZ-8plus³ are SXGA+, SXGA and SVGA. Plus it can also output the original Progressive Scan signal converted into PAL or NTSC video (switchable).

All widescreen projectors, monitors or plasma displays on the market can display at least one of these standards.

All current WolfVision Visualizer models can pick up 30 pictures (frames) per second in every resolution. There is almost no difference in the smoothness of motion, when compared to PAL/NTSC video cameras. But the resolution is much higher!

VZ-8plus³ and VZ-8light³ output the image on RGB (15-Pin D-Sub) and DVI outputs.

The DVI port on the VZ-8light³ is a new feature of the "third generation". There was no DVI port on VZ-8light².

Auto Resolution: The Visualizer recognizes units connected to the DVI and RGB output and automatically selects the perfect output mode.



connectors of VZ-8plus³



connectors of VZ-8light³

Easy Handling Concept / Zoom Wheel



For smooth presentations, it is necessary that the Visualizer is very easy to use. Everyone should be able to operate the unit immediately, without any instructions.

Normally users need only to use the zoom wheel on top of the camera head. Everything else (focus, iris etc.) is adjusted automatically.

The zoom wheel offers the possibility to zoom with two speeds.

The other 5 keys on the camera head include important functions like autofocus on/off, manual focus, freeze and Ext/Int. More functions are available on the remote control of the VZ-8plus³.

Most functions on the Visualizer can also be controlled without remote control. Functions like menu settings and Preset 1 are available as double functions if the keys on the camera head are pressed for 1 second.

No Focus Adjustments Necessary

The continuously working autofocus recognizes every object quickly and precisely. As a result, the presenter never needs to worry about focusing. The high speed of the autofocus is due to a special WolfVision software, which is analyzing 30 frames per second.

For special objects, a manual focus is also available.



No Light Adjustments Necessary

The light system is optimized for the working surface and there is never a need for any light adjustments.

The camera arm can be moved up and down at an angle of 90 degrees. The light is fixed onto the camera arm and moves together with the camera. Therefore, it is also possible to illuminate the area in front or behind the working surface.

The light of the Visualizers is focused on the working surface. Neither the audience nor the speaker will be blinded in a darkened room and there is no disturbing stray light from the Visualizer on the projection screen.

For recording objects at greater distances to the device, the close-up lens of the Visualizers can be hinged away from the camera. It won't get lost because it remains attached to the unit.



Recordings Behind the Unit

When objects are too big to be placed on the working surface or need to be shown from the side (like glasses of liquids etc.), the camera head and the light of the portable Visualizers can be turned to accommodate them.

In this way a Visualizer can be used like a video camera, to record people, large objects, pictures or charts in a room.

Recordings in Front of the Unit - with "Image Flip"

The Visualizer can not only record objects from behind the unit. The camera head can also be turned to record in front of the unit.

This is perfect for recording a speaker or charts on a wall behind the speaker. When the camera is turned to record in front of the unit, the image is automatically turned around 180 degrees ("image flip"), because normally such recordings would be upside down.



220° Tilt Range of Camera

Not many Visualizers can record outside of the working surface because tilting the camera and light requires high-grade mechanical components.

WolfVision's VZ-8 series Visualizers feature a very sophisticated camera/light hinge which provides a large shooting area outside of the working surface.

The total tilt range of the camera is 220 degrees.

The camera can be tilted 100° towards the audience and 120° towards the speaker.



Unique folding system / Set up in seconds



The Visualizer can be set up in seconds. A gentle tug lifts the arm and light into the working position. The user then needs only to turn the camera head to the desired viewing angle. Just as easily, it folds back into its compact size with just one pull on the center ring, to be neatly stored during or after a presentation. The units fit perfectly in a drawer. The height when folded is only 123mm (4.9").

100% Reflection free

Due to the clever design of the Visualizer's housing, the whole working surface is completely reflection free. In the upper part the working surface, where the light is normally reflected into the camera, the surface is slightly curved, so that reflections are not possible on any part of the working surface.

The flat design also allows moving objects around on the whole working surface without any obstacles. Even oversized documents (like the calendar seen in the picture on the left) can be moved to the back without being blocked by the device.



Firmware Updates via RS232 or USB

WolfVision's Visualizers are the only units on the market that offer upgradeable firmware. This allows new features and technical improvements to be added at no cost!

Downloading firmware updates from the internet and uploading them onto a Visualizer can be done in 2-3 minutes, with just 4 mouse clicks, using the latest version of WolfVision's Connectivity Software. Firmware Updates can be made using the Serial (RS232) or USB port of the Visualizer.

WolfVision's engineers are constantly working on new improvements and features to keep your units up to date with the technology of tomorrow!



Max. 370 x 276mm (14.6" x 10.9")



24 time zoom
24 times smaller

24x Zoom (12x Optical and 2x Digital)

A large optical zoom range is one of the most important features of a Visualizer. It is absolutely necessary that objects in every size can be picked up in full resolution.

WolfVision's optical 12 times zoom offers the possibility to pick up objects as large as an open book (370 x 276mm / 14.6" x 10.9") and as small as a stamp (33 x 25mm / 1.3" x 1") in full size to fill the screen.

For enlarging even smaller objects down to 17 x 13mm (0.7" x 0.5") the Visualizers also offer a 2x digital zoom. This enables users to enlarge objects such as a very small coin.

Due to the large range optical zoom, it is seldom necessary to use the digital zoom. In most cases, you can work with full resolution.



Min. 17 x 13mm (0.7" x 0.5")

Computer Input (Internal/External Switch)

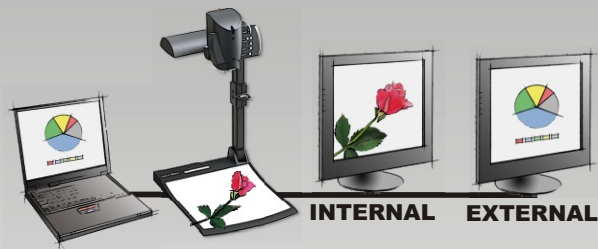

A computer can be connected to the RGB input (15-pin D-Sub-plug) of the Visualizer. With the Ext/Int switch, a user can switch between the Visualizer image and computer image to be output by the Visualizer's RGB output (15-pin D-Sub-plug).

Therefore, only one RGB cable is required to be attached to the display unit (projector, monitor, video conferencing system etc.) and no separate remote control has to be used for switching between the two image sources.

"Image Turn" Mode for Higher Resolution

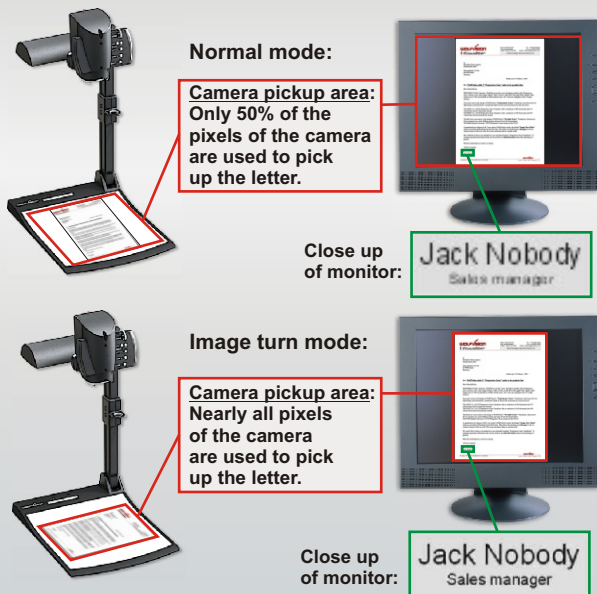

Picking up a complete vertical (portrait) letter or A4 sized page has always been a critical issue for a Visualizer because the image has always been picked up in a horizontal (landscape) format. As a result, only 50% of the camera pixels could be used to pick up the vertical (portrait) document.

WolfVision's unique "Image Turn" mode solves this problem. The user places the document on the working surface horizontally and zooms in on it completely. In doing so, approximately 90% of the camera's effective pixels are used to pick up the document. WolfVision's state-of-the-art electronics turn the image to a 90 degree angle and output it in a vertical format with 40% higher resolution. The margins left and right are blacked out.

In this mode, the resolution of a complete vertical (portrait) document is much better. Even 8-point characters are now readable.

Another advantage of the image turn mode is that very long vertical pages (like US legal format) can be picked up completely.

USB 2.0 port / Twain / Video Capture



The USB port of the Visualizer can be used to transfer images from a Visualizer to a computer and save them in JPG, TIF or BMP format. This way, Visualizers can be used as scanners for 3-dimensional objects.

WolfVision's USB Software (Connectivity Software) works under Windows 2000, XP and Vista and is fully Twain compatible. This is important when using Visualizers in connection with popular graphic programs such as Photoshop, or for connecting them to Interactive Whiteboards (Smart Boards). A USB Software for Apple Macintosh is also available.

WolfVision Visualizers are equipped with a fast USB 2.0 port. This allows for uploading images onto a PC in a fraction of a second. It can also output live motion. The WolfVision Connectivity Software can store AVI-files and includes a video capture driver. You can view and save the live image from the Visualizer on your computer in almost every modern video editing software.

Optimized for Video Conferencing



WolfVision's camera electronics produce a very strong and stable picture, which is very important when a Visualizer is used as a document camera for videoconferencing systems.

The even lighting, smooth auto iris and perfect focus are very important features, enabling video conferencing systems to digitize and transfer the picture from a WolfVision Visualizer much faster than pictures from other document cameras. Furthermore there is no blinding stray light from a WolfVision Visualizer, which could disturb the auto iris of the room camera.

Of course these features are equally important for live image presentations with a data projector and for other Visualizer applications.

Special Surface for Transparencies



All WolfVision Visualizers have a special crystalline white working surface for perfect reproduction of transparencies. The quality of a transparency on this surface is even better than with a bottom light, because there is more contrast and the colors are not "washed out". The whole working surface has the same even color thus providing the perfect background for transparencies and other objects.

For x-rays or oversized slides, external lightboxes are available.

9 Picture Memory



The VZ-8plus³ can store 9 images and recall them by just pressing one of the numerical keys on the infrared remote control.

By pressing the "All" key, a split image with all 9 pictures of the memory can be displayed, enabling easy selection. The 9 pictures in the memory can also be downloaded to a PC via USB and they remain in the memory even when the power is disconnected.

The VZ-8light³ offers a 1 image freeze function, instead of the 9 picture memory.

Infrared Remote Control / Additional Features



The VZ-8plus³ is supplied with a remote control. In addition to the features described above, the remote control also offers:

- Manual focus
- Auto focus on/off
- Manual iris
- 3 user programmable presets
- Laser pointer
- Easy navigation for on-screen menu and on-screen help

External Controlling

There are 3 different possibilities to control the Visualizers from external devices, such as a room control system, a video conferencing system or a computer:

- Serial RS232
- USB
- Infrared (VZ-8plus³)

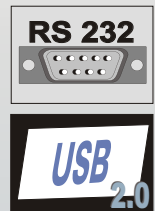

Anti-theft devices

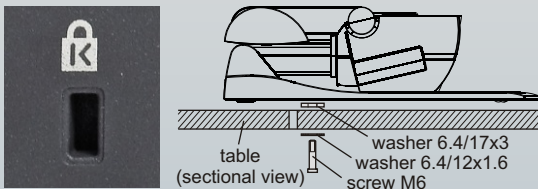

The Visualizer has two anti-theft devices.

On the bottom of the working plate is a thread for attaching the unit to a table with the supplied **Table Lock Bolt**.

T-Lock (Kensington® Lock) devices can also be used. The connection can be found on the bottom of the arm.



Slide Drawer

Slides can be picked up in exceptional quality without an external bottom light by just putting them into the slide drawer on the camera head of the VZ-8plus³.

Dimensions

Detailed dimension drawings at: www.wolfvision.com/support

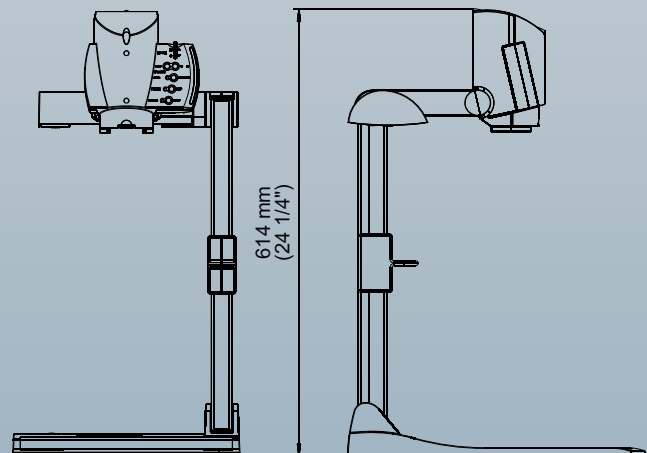
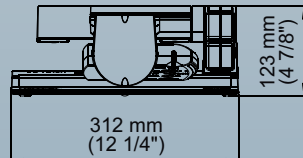
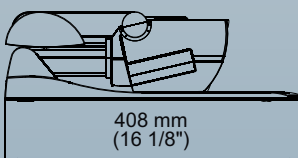

Technical Data

	VZ-8light ³	VZ-8plus ³
Camera	1-CCD 1/3" Progressive Scan	1-CCD 1/3" Progressive Scan
Pictures per second (as picked up by the camera)	30 frames (in all resolutions)	30 frames (in all resolutions)
Effective Pixel (=pixels actually used for image information)	1280 x 960 (=1,228,800)	1280 x 960 (=1,228,800)
Total pixels of CCD(s)	1,320,000	1,320,000
Pixels processed per second (=effective pixels x frames per sec.)	36,864,000	36,864,000
Color reproduction / precision	very good colors (sRGB color precision)	very good colors (sRGB color precision)
Native signal output	SXGA- (1280x960) and 720p HD (1280x720)	SXGA- (1280x960) and 720p HD (1280x720)
Converted output signals (4:3 and 5:4)	XGA (1024x768)	SXGA+ (1360x1024), SXGA (1280x1024), XGA (1024x768), SVGA (800x600), PAL and NTSC
Converted Widescreen output signals (16:9 and 16:10)	WXGA (1360x768)	WXGA (1360x768)
Resolution (measured)	750 lines	750 lines
Resolution in Image Turn mode	-	960 lines
Image Turn mode (for increased resolution when picking up large portrait pages)	-	yes
Image Rotation	-	90, 180 and 270 degrees
Vertical image-frequency	60 Hz	50 and 60 Hz
Horizontal image-frequency	45 - 60 kHz	15.7 and 37.9 - 65.2 kHz
Signal format	non-interlaced	non-interlaced and interlaced
Iris	automatic (manual in on-screen menu)	automatic and manual
White balance adjustment	automatic and manual	automatic and manual
Autofocus / Speed	yes (continuously working, high speed)	yes (continuously working, high speed)
Manual focus	yes	yes
Text Enhancer	yes	yes
On screen menu and on screen help	yes	yes
Firmware Updates via	USB, RS232	USB, RS232
Zoom / Lens	24 x zoom (12x optical + 2x digital), with 2-speed zoom wheel	24 x zoom (12x optical + 2x digital), with 2-speed zoom wheel
Max. object height on working surface	230mm (9.6") in tele position 370mm (15") in wide	230mm (9.6") in tele position 370mm (15") in wide
Max. pick-up area on working surface	length: 276mm (10.9"), width: 370mm (14.6")	length: 276mm (10.9"), width: 370mm (14.6")
Max. pick-up area on working surface in Image Turn mode	-	length: 370mm (14.6"), width: 276mm (10.9")
Min. pick-up area on working surface (full resolution, optical zoom)	33 x 25 mm (1.3" x 1")	33 x 25 mm (1.3" x 1")
Min. pick-up area on working surface (with digital zoom)	17 x 13 mm (0.7" x 0.5")	17 x 13 mm (0.7" x 0.5")
Max. pick-up area outside of working surface	unlimited	unlimited
Depth of focus on small object (42 x 33 mm)	10mm (0.4")	10mm (0.4")
Depth of focus on large object (360 x 270 mm)	260mm (10.2")	260mm (10.2")
Tilt range of camera	220° (120° to speaker + 100° to audience)	220° (120° to speaker + 100° to audience)
Blinding of audience or speaker	none	none
Light source	long life high frequency fluorescent lamp, average lifetime 10,000 hours, 9W, 48V	long life high frequency fluorescent lamp, average lifetime 10,000 hours, 9W, 48V
Connectivity Software (USB/LAN, for controlling, image and video capturing and firmware updates)	included (for Windows and Macintosh, Twain compatible, with video capture driver)	included (for Windows and Macintosh, Twain compatible, with video capture driver)
Reflection free area on working surface	whole working surface	whole working surface
Recordings outside of the working surface	yes (to the back and to the front of the unit)	yes (to the back and to the front of the unit)
Automatic image flip	yes (for recordings to the front of the unit)	yes (for recordings to the front of the unit)
Intelligent folding system	pneumatic arm, 2-step set up	pneumatic arm, 2-step set up
User programmable presets	1 (plus 2 programmable and 8 fixed through RS232)	3 (plus 8 fixed presets through RS232)
Special working surface for transparencies	yes	yes
Slide pick-up	with optional lightbox	through slide drawer on camera head
External computer input / Input switch	yes (15-pin D-Sub/VGA plug)	yes (15-pin D-Sub/VGA plug)
Image memory	1 image freeze	9 pictures
"Show all" function (9 picture split-screen)	-	yes
Alternative Image display	negative / negative-blue / black & white	negative / negative-blue / black & white
Y/C (=S-video) output	-	one (converted Prog.Scan), 4-pin
Composite video outputs	-	one (converted Prog.Scan), RCA
RGB output	one (15-pin D-Sub/VGA-plug)	one (15-pin D-Sub/VGA-plug)
DVI output	DVI-D (digital)	DVI-D (digital)
HDMI output	when using a DVI-HDMI cable	when using a DVI-HDMI cable
USB port / standard	USB 2.0	USB 2.0
RS232 port (serial protocol with position setting and status report)	9-pin D-Sub	9-pin D-Sub
Weight	5 kg (11 lbs)	5 kg (11 lbs)
Infrared remote control	-	yes (with laserpointer)
Anti-theft device	T-Lock (Kensington® Lock) and table lock bolt	T-Lock (Kensington® Lock) and table lock bolt
Power (external power pack on portable units)	multi range 100-240 V, 60W, weight: 0.3kg (0.6lbs)	multi range 100-240 V, 60W, weight: 0.3kg (0.6lbs)
Dust cover	included	included
Warranty	3 years	3 years

Printed in Austria, February 2009

All units made in European Union (Austria)

Design and specifications subject to change!

Your WolfVision dealer:



More information at:
www.wolfvision.com

Head office:	WolfVision GmbH, Klaus/Austria	Tel. ++43/5523/52250, Fax ++43/5523/52249	wolfvision@wolfvision.com
USA distribution:	WolfVision Inc, Duluth (Atlanta) WolfVision Inc, Burlingame (San Francisco)	Tel.(770)931-6802, Tollfree 1-877-873WOLF, Fax:(770)931-6906 Tel.(650)648-0002, Tollfree (800)356-WOLF, Fax:(650)648-0009	usa.east@wolfvision.com usa.west@wolfvision.com
Asia distribution:	WolfVision Asia, Singapore	Tel.++65-6366 9288, Fax: ++65-6366 9280	info@wolfvisionasia.com
Canada distribution:	Wolfvision Canada Inc, Ottawa	Tel. 613-741-9898, Fax 613-741-3747	wolfvision.canada@wolfvision.com
Japan distribution:	WolfVision Co Ltd, Tokyo	Tel.(+81)3-33603231, Fax:(+81)3-33603236	wolfvision.japan@wolfvision.com
UK distribution:	WolfVision UK Ltd, Manchester	Tel. 0161 435 6081, Fax: 0161 435 6100	wolfvision.uk@wolfvision.com