

**TOSHIBA**



**DVD VIDEO RECORDER / VIDEO CASSETTE RECORDER  
 DVR620KU**

*OWNER'S MANUAL*



TOSHIBA DVD VIDEO RECORDER / VIDEO CASSETTE RECORDER DVR620KU



**Owner's Record**

The model number and serial number are on the back of your DVD Recorder. Record these numbers in the spaces below. Refer to these numbers whenever you communicate with your Toshiba dealer about this DVD Recorder.

Model number:

Serial number:

**TOSHIBA**

E9PKFUH / 2VMN00046  
 Printed in China ★★★★★



# PRECAUTIONS

**WARNING:** TO REDUCE THE RISK OF FIRE OR ELECTRIC SHOCK, DO NOT EXPOSE THIS APPARATUS TO RAIN OR MOISTURE. APPARATUS SHALL NOT BE EXPOSED TO DRIPPING OR SPLASHING AND NO OBJECTS FILLED WITH LIQUIDS, SUCH AS VASES, SHALL BE PLACED ON THE APPARATUS.



**CAUTION**  
**RISK OF ELECTRIC SHOCK**  
**DO NOT OPEN**



**CAUTION:**

TO REDUCE THE RISK OF ELECTRIC SHOCK, DO NOT REMOVE COVER (OR BACK). NO USER SERVICEABLE PARTS INSIDE. REFER SERVICING TO QUALIFIED SERVICE PERSONNEL.



The lightning flash with arrowhead symbol, within an equilateral triangle, is intended to alert the user to the presence of uninsulated "dangerous voltage" within the product's enclosure that may be of sufficient magnitude to constitute a risk of electric shock to persons.



The exclamation point within an equilateral triangle is intended to alert the user to the presence of important operating and maintenance (servicing) instructions in the literature accompanying the appliance.

The important note and rating are located on the rear or bottom of the cabinet.



The symbol for CLASS II (Double Insulation)

## IMPORTANT SAFETY INSTRUCTIONS

1. Read these instructions.
2. Keep these instructions.
3. Heed all warnings.
4. Follow all instructions.
5. Do not use this apparatus near water.
6. Clean only with dry cloth.
7. Do not block any ventilation openings. Install in accordance with the manufacturer's instructions.
8. Do not install near any heat sources such as radiators, heat registers, stoves, or other apparatus (including amplifiers) that produce heat.
9. Do not defeat the safety purpose of the polarized or grounding-type plug. A polarized plug has two blades with one wider than the other. A grounding type plug has two blades and a third grounding prong. The wide blade or the third prong are provided for your safety. If the provided plug does not fit into your outlet, consult an electrician for replacement of the obsolete outlet.
10. Protect the power cord from being walked on or pinched particularly at plugs, convenience receptacles, and the point where they exit from the apparatus.
11. Only use attachments/accessories specified by the manufacturer.
12. Use only with the cart, stand, tripod, bracket, or table specified by the manufacturer, or sold with the apparatus. When a cart is used, use caution when moving the cart/apparatus combination to avoid injury from tip-over. 
13. Unplug this apparatus during lightning storms or when unused for long periods of time.
14. Refer all servicing to qualified service personnel. Servicing is required when the apparatus has been damaged in any way, such as power-supply cord or plug is damaged, liquid has been spilled or objects have fallen into the apparatus, the apparatus has been exposed to rain or moisture, does not operate normally, or has been dropped.

### Additional Safety Instructions

15. Do not overload wall outlets; extension cords, or integral convenience receptacles as this can result in a risk of fire or electric shock.
16. Keep your fingers well clear of the disc tray as it is closing. Neglecting to do so may cause serious personal injury.
17. Do not place a heavy object on or step on the apparatus. The object may fall, causing serious personal injury and serious damage to the apparatus.
18. Do not use a cracked, deformed, or repaired disc. These discs are easily broken and may cause serious personal injury and apparatus malfunction.
19. If the apparatus should smoke or smell, immediately disconnect the power cord from the wall outlet. Wait until the smoke or smell stops, then ask your dealer for a check and repair. Neglecting to do so may cause a fire.
20. While it is thundering, do not touch the connecting cables or the apparatus.
21. Warning: To prevent the spread of fire, keep candles or other open flames away from this product at all times.
22. Disconnect the mains plug to shut off when find trouble or not in use. The mains plug shall remain readily operable.

# PRECAUTIONS

## FCC WARNING

This equipment may generate or use radio frequency energy. Changes or modifications to this equipment may cause harmful interference unless the modifications are expressly approved in the manual. The user could lose the authority to operate this equipment if an unauthorized change or modification is made.

## RADIO-TV INTERFERENCE

This equipment has been tested and found to comply with the limits for a Class B digital device, pursuant to Part 15 of the FCC Rules. These limits are designed to provide reasonable protection against harmful interference in a residential installation. This equipment generates, uses, and can radiate radio frequency energy and, if not installed and used in accordance with the instructions, may cause harmful interference to radio communications. However, there is no guarantee that interference will not occur in a particular installation. If this equipment does cause harmful interference to radio or television reception, which can be determined by turning the equipment off and on, the user is encouraged to try to correct the interference by one or more of the following measures:

- 1) Reorient or relocate the receiving antenna.
- 2) Increase the separation between the equipment and receiver.
- 3) Connect the equipment into an outlet on a circuit different from that to which the receiver is connected.
- 4) Consult the dealer or an experienced radio/TV technician for help.

**ALWAYS plug the product into an outlet that is located in such a manner that it can be easily unplugged in case the product requires service.**

**CAUTION:** Danger of explosion if battery is incorrectly replaced. Replace only with the same or equivalent type.

**WARNING:** Batteries (Battery pack or battery installed) shall not be exposed to excessive heat such as sunshine, fire or the like.

## LASER SAFETY

This apparatus is classified as a CLASS 1 LASER PRODUCT.

This apparatus employs a laser. Only a qualified service person should remove the cover or attempt to service this apparatus, due to possible eye injury.

**CAUTION:** Use of controls or adjustments or performance of procedures other than those specified herein may result in hazardous radiation exposure.

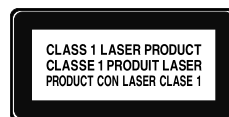

## IMPORTANT COPYRIGHT INFORMATION

Unauthorized copying, broadcasting, public performance and lending of discs are prohibited. This item incorporates copy protection technology that is protected by U.S. patents and other intellectual property rights of Rovi Corporation. Reverse engineering and disassembly are prohibited.

Do not place the unit on the furniture that is capable of being tilted by a child and an adult leaning, pulling, standing or climbing on it. A falling unit can cause serious injury or even death.

Never use a gas duster on this unit.

The gas trapped inside of this unit may cause ignition and explosion.

**WARNING:** This product contains chemicals, including lead, known to the State of California to cause cancer and birth defects or other reproductive harm. Wash hands after handling.

## To Avoid the Hazards of Electrical Shock and Fire

- Do not handle the power cord with wet hands.
- Do not pull on the power cord when disconnecting it from an AC outlet. Grasp it by the plug.
- Do not put your fingers or objects into the unit.

## Location and Handling

- Do not install the unit in direct sunlight, near strong magnetic fields, or in a place subject to dust or strong vibration.
- Avoid a place with drastic temperature changes.
- Install the unit in a horizontal and stable position. Do not place anything directly on top or bottom of the unit. Depending on your external devices, noise or disturbance of the picture and/or sound may be generated if the unit is placed too close to them. In this case, please ensure enough space between the external devices and the unit.
- Depending on the environment, the temperature of this unit may increase slightly. This is not a malfunction.
- Be sure to remove the disc and unplug the AC power cord from the outlet before carrying the unit.

# PRECAUTIONS

## Dew Condensation Warning

- Dew condensation may form inside the unit in the following conditions. If so, do not use this unit at least for a few hours until its inside gets dry.
  - The unit is moved from a cold place to a warm place.
  - Under conditions of high humidity.
  - After heating a cold room.

## Note about Recycling

- This unit's packaging materials are recyclable and can be reused. Please dispose of any materials in accordance with your local recycling regulations.
- Batteries should never be thrown away or incinerated but disposed of in accordance with your local regulations concerning chemical wastes.



## Notice for Progressive Scan Output

- Consumers should note that not all high definition television sets are fully compatible with this product and may cause artifacts to be displayed in the picture. In case of picture problems with 525(480) progressive scan output, it is recommended that the user switch the connection to the 'standard definition' output. If there are questions regarding your TV set compatibility with this 525p(480p) DVD player, please contact Toshiba Customer Service.

## Installation Location

For safety and optimum performance of this unit:

- Install the unit in a horizontal and stable position. Do not place anything directly on top of the unit. Do not place the unit directly on top of the TV.
- Shield it from direct sunlight and keep it away from devices of intense heat. Avoid dusty or humid places. Avoid places with insufficient ventilation for proper heat dissipation. Do not block the ventilation holes on the sides of the unit. Avoid locations subject to strong vibration or strong magnetic fields.

## Avoid the Hazards of Electrical Shock and Fire

- If, by accident, water is spilled on this unit, unplug the power cord immediately and take the unit to our Authorized Service Center for servicing.

## About Copyright

The unauthorized recording, use, distribution, or revision of television programs, videotapes, DVDs and other materials, is prohibited under the copyright laws of the United States and other countries, and may subject you to civil and/or criminal liability.

## Note to CATV system installer

This reminder is provided to call the cable TV system installer's attention to Article 820-40 of the National Electrical Code, which provides guidelines for proper grounding - in particular, specifying that the cable ground shall be connected to the grounding system of the building, as close to the point of cable entry as possible.

## Supplied Accessories

remote control with  
AA (1.5V) battery x 2

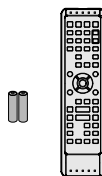

owner's manual

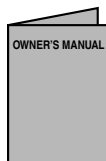

RCA audio/video cables

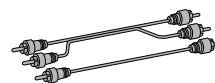

quick setup guide

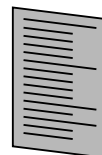

return stop sheet



warranty sheet

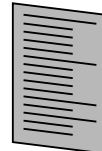

# PRECAUTIONS

## Maintenance

### Servicing

- Please refer to relevant topics on "TROUBLESHOOTING" on pages 103-106 before returning the product.
- If you need to call a customer service representative, please know the model number and serial number of your product before you call. This information is displayed on the back of the product. Also, please take a moment to identify the problem you are having, and be prepared to explain this to the representative. If you believe the representative will need to help you with operations, please stay near the product. Our representatives will be happy to assist you.

### Cleaning the Cabinet

- Wipe the front panel and other exterior surfaces of the unit with a soft, slightly damp cloth.
- Never use a solvent, thinner, benzene or alcohol to clean the unit. Do not spray insecticide liquid near the unit. Such chemicals may discolor the surface or damage the unit.

### Cleaning Discs

- When a disc becomes dirty, clean it with a cleaning cloth. Wipe the disc from the center to out. Do not wipe in a circular motion.
- Do not use solvents such as benzene, thinner, commercially available cleaners, detergent, abrasive cleaning agents or antistatic spray intended for analog records.

### Cleaning the Disc Lens

- If this unit still does not perform properly although you refer to the relevant sections and to "TROUBLESHOOTING" in this owner's manual, the laser optical pickup unit may be dirty. Consult your dealer or an Authorized Service Center for inspection and cleaning of the laser optical pickup unit.

### Disc Handling

- Handle the discs so that fingerprints and dust do not adhere to the surfaces of the discs.
- Always store the disc in its protective case when it is not used.

### Auto Head Cleaning

- Automatically cleans video heads as you insert or remove a cassette, so you can see a clear picture.
  - Playback picture may become blurred or interrupted while the TV program reception is clear. Dirt accumulated on the video heads after a long period of use, or the usage of rental or worn tapes can cause this problem. If a streaky or snowy picture appears during playback, the video heads in your unit may need to be cleaned.
1. Please visit your local Audio/Video store and purchase a good quality VHS video head cleaner.
  2. If a video head cleaner does not solve the problem, please consult your dealer or an Authorized Service Center.

### Note

- Remember to read the instructions along with the video head cleaner before use.
- Clean video heads only when problems occur.

## IR Signal Check

If the remote control does not work properly, you can test if the remote control sends out the infrared signal with AM radio or a digital camera (including built-in camera of cellular phone). It will help to define the cause of malfunction.

### • With an AM radio:

Tune an AM radio to a station with no broadcasting. Press a button on remote control toward the radio. Sound will be fluttering when you press any key and the radio receives the signal. This means the remote control is working.

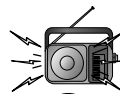

### • With a digital camera (including built-in camera of cellular phone):

Direct a digital camera to remote control, press and hold a button on remote control. If infrared light appears through digital camera, the remote control is working.



Manufactured under license from Dolby Laboratories. Dolby and the double-D symbol are trademarks of Dolby Laboratories.

### Dolby Digital Recording

"Dolby® Digital Recording enables consumers to record high-quality video with stereo sound on recordable DVD discs. The technology, when utilized instead of PCM recording, also saves recordable disc space, allowing for higher video resolution or extended recording time on each DVD. DVDs created using Dolby Digital Recording will play back on all DVD-video players."

**Note:** This is true when the players are compatible with actual recordable DVD discs.



Manufactured under license under U.S. Patent #: 5,451,942 & other U.S. and worldwide patents issued & pending. DTS and DTS Digital Out are registered trademarks and the DTS logos and Symbol are trademarks of DTS, Inc. ©1996-2008 DTS, Inc. All Rights Reserved.



HDMI, the HDMI logo and High-Definition Multimedia Interface are trademarks or registered trademarks of HDMI Licensing LLC.



DivX, DivX Certified, and associated logos are trademarks of DivX, Inc. and are used under license.

"WMA" (Windows Media Audio) is a new audio codec developed by Microsoft® in the United States of America.

# CONTENTS

## Introduction

<b>PRECAUTIONS</b> .....	<b>2</b>
<b>FEATURES</b> .....	<b>8</b>
Symbols Used in this Owner's Manual .....	8
<b>FUNCTIONAL OVERVIEW</b> .....	<b>11</b>
Installing the Batteries in the Remote Control .....	12
Using a Remote Control .....	12
<b>THE VCR / DVD RECORDER SWITCHING</b> .....	<b>14</b>
<b>GUIDE TO ON-SCREEN DISPLAYS AND MENUS</b> .....	<b>15</b>
On-Screen Display / Menu .....	15
Main Menu .....	17
<b>FRONT PANEL DISPLAY GUIDE</b> .....	<b>18</b>

## Connections

<b>CONNECTIONS</b> .....	<b>19</b>
Connecting to an External Tuner .....	19
TV Connection Overview .....	19
Connecting to a TV with an HDMI Compatible Port .....	20
Connecting to a TV with Component Video Input Jacks .....	21
Connecting to a TV with an S-Video Input Jack .....	21
Connecting to a TV with Audio / Video Input Jacks ..	22
Connecting to a TV without Audio / Video Input Jacks .....	22
Digital Audio Connection .....	23

## Basic Setup

<b>INITIAL SETTING</b> .....	<b>25</b>
<b>SETTING THE CLOCK</b> .....	<b>26</b>
Clock Setting .....	26
<b>SETTINGS FOR THE VIDEO INPUT</b> .....	<b>27</b>

## Disc Management

<b>FORMATTING A DISC</b> .....	<b>28</b>
Choosing the Recording Format of a Brand-New DVD-RW .....	28
Reformatting a Disc Manually .....	29
<b>SETTING A DISC TO PROTECT</b> .....	<b>30</b>
<b>PLAYING THE DISCS IN OTHER DVD PLAYERS</b> .....	<b>31</b>
Auto Finalizing .....	31
Finalizing a Disc .....	32

## Recording

<b>INFORMATION ON DVD RECORDING</b> .....	<b>34</b>
Recording Mode .....	34
Restrictions on Recording .....	34
<b>SETTINGS FOR A RECORDING</b> .....	<b>35</b>
Make Recording Compatible .....	35
Setting for Auto Chapter .....	35
Recording Audio Select (XP) .....	36
Setting Aspect Ratio for Video Mode Recording .....	36
<b>BASIC RECORDING &amp; ONE-TOUCH TIMER RECORDING</b> .....	<b>37</b>
<b>TIMER RECORDING</b> .....	<b>39</b>
Hints for Timer Recording .....	42
<b>SATELLITE LINK</b> .....	<b>43</b>
<b>SETTINGS FOR AN EXTERNAL DEVICE</b> .....	<b>45</b>
Connection to an External Device .....	45
Recording from an External Device .....	46
<b>DV DUBBING</b> .....	<b>47</b>
Guide to DV and On-Screen Display .....	47
DVC to DVD Dubbing .....	48
DVC to VCR Dubbing .....	49
<b>DVD/VCR DUBBING</b> .....	<b>50</b>

## Playback

<b>INFORMATION ON PLAYBACK</b> .....	<b>52</b>
Structure of Disc Contents .....	52
<b>BASIC PLAYBACK</b> .....	<b>53</b>
Direct Playback .....	53
Playback from the Title List .....	54
Playing Back an Audio CD and a CD-RW/-R with MP3/WMA/JPEG Files .....	55
Playing Back a DivX® .....	56
Using the Title/Disc Menu .....	58
Pause .....	58
<b>SPECIAL PLAYBACK</b> .....	<b>59</b>
Resume Playback .....	59
Fast Forward / Fast Reverse Playback .....	59
Skipping TV Commercials During Playback .....	59
Rapid Playback .....	60
Step by Step Playback .....	60
Slow Forward / Slow Reverse Playback .....	60
Zoom .....	61
Marker Setting .....	61
Chasing Playback during Recording .....	62
Simultaneous Playback and Recording .....	63
<b>SEARCH</b> .....	<b>64</b>
Title/Chapter Search .....	64
Track Search .....	64
Time Search .....	65
<b>REPEAT/RANDOM/PROGRAM PLAYBACK/ SLIDE SHOW</b> .....	<b>66</b>
Repeat Playback .....	66
Random Playback .....	66
Program Playback .....	67
Slide Show .....	67
<b>SELECTING THE FORMAT OF AUDIO AND VIDEO</b> ..	<b>68</b>
Switching Subtitles .....	68
Switching Audio Soundtrack .....	68
Switching Virtual Surround System .....	69
Switching Camera Angles .....	69
Reducing Block Noise .....	69
Adjusting Black Level .....	70

## Editing

<b>INFORMATION ON DISC EDITING</b> .....	<b>71</b>
Guide to a Title List .....	71
Editing Discs .....	71
<b>DELETING TITLES</b> .....	<b>72</b>
<b>CREATING/DELETING PLAYLIST</b> .....	<b>74</b>
Adding Titles to a Playlist .....	74
Erasing All Playlist .....	75
<b>EDITING DISCS</b> .....	<b>76</b>
Putting Names on Titles .....	76
Setting Chapter Marks .....	78
Hiding Chapters .....	79
Deleting a Part of a Title .....	80
Dividing a Title .....	82
Combining Titles .....	83
Setting or Releasing the Title Protection .....	84
Setting or Clearing All Chapter Marks at Once .....	85

## Function Setup

<b>LIST OF THE DEFAULT SETTINGS</b> .....	<b>86</b>
<b>GENERAL SETTING</b> .....	<b>88</b>
Playback .....	88
Display .....	92
Video .....	95
DivX® .....	96
HDMI .....	97
Reset All .....	99

## VCR Function

<b>VCR FUNCTIONS</b> .....	<b>100</b>
Information on VCR Functions .....	100
Playback .....	100
Recording .....	100
One-touch Timer Recording (OTR) .....	101
Index Search .....	101
Time Search .....	102
Other Operations .....	102

## Others

<b>TROUBLESHOOTING</b> .....	<b>103</b>
Frequently Asked Questions .....	106
<b>LANGUAGE CODE</b> .....	<b>107</b>
<b>GLOSSARY</b> .....	<b>108</b>
<b>SPECIFICATIONS</b> .....	<b>109</b>

# FEATURES

This unit not only plays back DVD, CD and cassette tape but also offers features for you to record on DVD/cassette tape and edit them after that. The following features are offered with this unit.

## Recording

**DVD mode** **VCR mode**

This unit is compatible with recording on DVD-RW/+RW which is recordable repeatedly and DVD-R/+R which accept the additional recordings until the disc becomes full but not overwritable. You can choose either one for your convenience. Also, this unit allows you to record to the cassette tape.

### Up to 12 program recording:

You can program the unit to record up to 12 programs, within a month in advance. Daily or weekly program recordings are also available.

### One-touch timer recording (OTR):

You can easily set a recording time as you prefer. Every time [REC ●] is pressed during recording, the recording time will be increased by 30 minutes up to 8 hours. The recording automatically stops when the recording time you set is reached.

### Dubbing mode:

You can copy a DVD to a cassette tape or copy a cassette tape to a DVD. This function will be possible only if the DVD or a cassette tape is not copy protected. You cannot record on a cassette tape when its erase-protection tab is removed.

### DV dubbing:

This function helps you to easily dub the contents of the DVC (digital video camcorder) to DVD, and DV (digital video) to VCR.

### Left channel stereo recording:

This unit can record the sound of the left channel monaural input as left and right channels automatically.

### Automatic chapter mark setting:

**DVD mode**

Chapter marks will be put on recordings as you set before attempting to record.

### Automatic title menu making:

The unit creates title menu automatically when finalizing discs.

### Automatic playlist making:

The unit creates a playlist automatically after recording VR mode DVD-RW.

### Automatic title finalizing:

For video mode DVD-RW/-R and DVD+R recording, you can finalize discs automatically after finishing all timer recordings or at the end of the disc space if you set this in the main menu.

## Playback

### Theater surround sound in your home:

**DVD mode**

When connecting the unit to an amplifier or a decoder which is compatible with Dolby Digital or DTS, you can experience the theater surround sound from discs with surround sound system.

### Quick search for what you want to watch:

You can easily find the part you want to watch using the search function. Search for a desired point on a disc by title, chapter/track or time.

### Virtual surround system:

You can enjoy stereophonic space through your existing 2 channel stereo system.

### Playing back MP3/WMA/JPEG/DivX® files:

You can enjoy MP3/WMA/JPEG/DivX® files which are recorded on CD-RW/-R.

DivX® files can also be recorded on DVD-RW/-R and DVD+RW/+R.

### Quick search for what you want to watch:

**VCR mode**

You can go to a specific point on a cassette tape by entering the exact amount of time you wish to skip.

You can easily find the part you want to watch using the index search/time search functions. An index mark will be assigned at the beginning of each recording you make. For time search function, you can go to a specific point on a cassette tape by entering the exact amount of time you wish to skip.

## Editing

### Deleting titles:

**DVD mode**

You can delete titles which you do not need anymore.

### Setting or clearing chapter marks:

You can set or clear chapter marks on titles.

### Hiding chapters:

To keep others from playing back some chapters without permission, you can hide chapters.

### Deleting parts of titles:

You can delete a specific part of a title.

### Dividing or combining titles:

You can divide or combine a title.

### Editing title names:

You can change the title name you prefer.

## Compatibility

**DVD mode**

### Available for playing back discs on a regular DVD player:

Recorded discs can be played back on regular DVD players, including computer DVD drives compatible with DVD-video playback. Although DVD+RW/+R are playable on other units without finalization in most cases, it is recommended to finalize in order to stabilize the performance.

## Others

### Progressive scan system

**DVD mode** **VCR mode**













Unlike conventional interlace scanning, the progressive scan system provides less flickering and images in higher resolution than that of traditional television signals.

### HDMI (High-Definition Multimedia Interface)

You can enjoy clearer audio/video output when connecting this unit to a display device with an HDMI-compatible port.

## Symbols Used in this Owner's Manual









To specify for what disc type each function is, we put the following symbols at the beginning of each item to operate.

Symbol	Description
<b>For Recording, Playing Back, and Editing</b>	
	Description refers to DVD-RW in video mode
	Description refers to DVD-RW in VR mode
	Description refers to DVD-R in video mode
	Description refers to DVD+RW
	Description refers to DVD+R
	Description refers to VHS tapes Use only cassettes marked VHS (VHS).
<b>For Playback only</b>	
	Description refers to DVD-video
	Description refers to audio CD
	Description refers to CD-RW/-R with MP3 files
	Description refers to CD-RW/-R with WMA files
	Description refers to CD-RW/-R with JPEG files
	Description refers to DVD-RW/-R, DVD+RW/+R and CD-RW/-R with DivX® files

If you do not find any of the symbols listed above under the function heading, the operation is applicable to all media.



# FEATURES

		Discs for Recording, Playing back				
Disc type	DVD-RW		DVD-R	DVD+RW	DVD+R	
Logo						
Format	Can be formatted in VR or video mode		Automatically formatted in video mode	Automatically formatted in +VR mode	Automatically formatted in +VR mode	
	Video Mode	VR Mode				
Icon						
Maximum record time	480 min (12cm) 144 min (8cm)	480 min (12cm) 144 min (8cm)	480 min (12cm) 144 min (8cm)	480 min (12cm) 144 min (8cm)	480 min (12cm) 144 min (8cm)	
Disc Speed Versions	1X-6X Ver.1.1/ 1.2 Ver.1.1/ 1.2 CPRM compatible		1X-16X Ver.2.0/ 2.1	1x-4x	1x-16x	
Compatibility	Playable on most DVD players. Finalization necessary. (title menu will be created)	Playable only on VR mode compatible unit. Finalization recommended.	Playable on most DVD players. Finalization necessary. (title menu will be created)	Playable on DVD+RW compatible players. Finalization recommended. (title menu will be created)	Playable on most DVD players. Finalization recommended. (title menu will be created)	
<b>Available Features</b>	<b>Recording Features</b>					
	Record TV programs	✓	✓	✓	✓	✓
	Reuse by deleting the current contents	✓	✓		✓	
	Record 16:9 size pictures	✓	✓	✓		
	Record copy-once programs		✓*			
	Create chapters at fixed intervals (auto chapter)	✓	✓	✓	✓	✓
	<b>Editing Features</b>					
			<b>Playlist</b>	<b>Original</b>		
	Scene delete		✓	✓		
	Edit title name	✓	✓	✓	✓	✓
	Create chapters wherever you like (chapter mark)		✓	✓	✓	✓
	Divide a title		✓		✓	
	Combine titles		✓			
	Hide chapters				✓	✓
	Delete a title	✓	✓	✓	✓	✓
Create a playlist			✓			
Protect a title			✓			

✓: Available    Gray: Not available  
\*CPRM compatible disc only.

Introduction

Connections

Basic Setup

Disc Management

Recording

Playback

Editing

Function Setup

VCR Function

Others

# FEATURES

Discs for playing back				
Disc Type	DVD-VIDEO	CD-DA	CD-RW	CD-R
Logo				
Icon				

Files for playing back				
Type of title	MP3	WMA	JPEG	DivX®
Icon				
Media	CD-RW/-R	CD-RW/-R	CD-RW/-R	CD-RW/-R DVD-RW/-R DVD+RW/+R

Recording/Playing back
VCR
Cassette Tape

**DVD** is a trademark of DVD Format/Logo Licensing Corporation.

- Official DivX® Certified product
- Plays all versions of DivX® video (including DivX® 6) with standard playback of DivX® media files
- Discs containing the DivX® files with the DivX® GMC (Global Motion Compensation) playback feature, which is DivX® supplemental function, cannot be played back on this unit.
- \* This unit cannot play back the disc contents protected by Windows Media Digital Rights Management (DRM).

## Unplayable Discs

The following discs will not play back on this unit.

- CD-ROM
- Compact Disc-Interactive (CD-I)
- Video Single Disc (VSD)
- DVD-ROM
- DVD-audio
- Unfinalized disc
- DVD-RW/-R recorded in non compatible recording format
- Blu-ray Disc
- HD DVD

On the following disc, the sound may not be heard.

- Super audio CD - Only the sound on the CD layer can be heard. The sound on the high-density super audio CD layer cannot be heard.

## Color Systems

DVD is recorded in different color systems throughout the world. The most common color system is NTSC (which is used primarily in the United States and Canada). This unit uses NTSC, so DVD you play back must be recorded in the NTSC system. You cannot play back DVD recorded in other color systems.

## Region Codes

This unit has been designed to play back DVD with region 1. DVD must be labeled for ALL regions or for region 1 in order to play back on the unit. You cannot play back DVD that are labeled for other regions. Look for the symbols on the right on your DVD. If these region symbols do not appear on your DVD, you cannot play back the DVD in this unit.



The number inside the globe refers to region of the world. A DVD labeled for a specific region can only play back on the unit with the same region code.

Following discs are recommended for good recording quality and are proven to be compatible with this unit. However, depending on the media condition, the unit may not read the disc properly.

- Verbatim DVD+R 8x, DVD+RW 4x, DVD-R 8x, DVD-RW 2x
- JVC DVD-RW 4x
- Maxell DVD+R 4x/8x/16x, DVD-R 8x/16x
- SONY DVD+R 4x/8x/16x, DVD+RW 4x
- TDK DVD+R 4x/8x/16x

Performance of any other discs are not guaranteed.

- Toshiba is not liable for any damage or loss caused directly or indirectly by the malfunction of this recorder, including, without limitation, any one of the following:
  - Failure to record contents intended to be recorded by the consumer.
  - Failure to edit contents as intended by the consumer.
  - When a DVD-RW/-R, DVD+RW/+R disc created on this recorder is used (e.g., insertion, playback, recording or editing) in another DVD player, recorder or personal computer drive.
  - When a DVD-RW/-R, DVD+RW/+R disc that is used in the manner described in the immediately preceding bullet point is used again in this recorder.
  - When a DVD-RW/-R, DVD+RW/+R disc that was recorded in another DVD recorder, or in a personal computer drive is used in this recorder.
- Some functions may not work with personal computer discs.
- Discs recorded in this recorder may not operate as expected on other DVD players, recorders or personal computer drives.

Because of problems and errors that can occur during the creation of DVD and CD software and/or the manufacture of DVD and CD discs, Toshiba cannot assure that this DVD Video Recorder will successfully play every disc bearing the DVD and CD logos. If you happen to experience any difficulty playing a DVD and/or CD disc on this DVD Video Recorder, please contact Toshiba Customer Service.

DVD players with **RW COMPATIBLE** are capable of playing DVD-RW recorded in VR mode.

# FUNCTIONAL OVERVIEW

## Front Panel

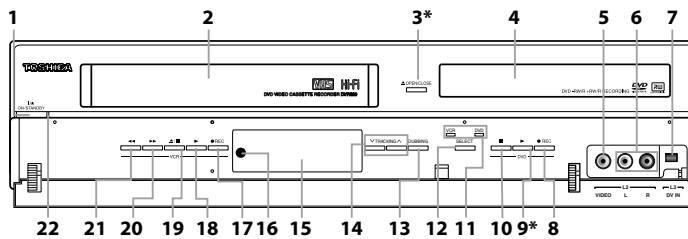

(\*) The unit can also be turned on by pressing these buttons or by inserting a cassette tape.

### 1. I/O ON/STANDBY button (DVD/VCR)

- Press to turn on the unit, or to turn the unit into the standby mode. (To completely shut down the unit, you must unplug the AC power cord.)

### 2. Cassette compartment (VCR)

- Insert a cassette tape here.

### 3. ▲ OPEN/CLOSE button (DVD)\*

- Press to open or close the disc tray.

### 4. Disc tray (DVD)

- Place a disc when it is open.

### 5. VIDEO input jack (L2) (DVD/VCR)

- Use to connect external device with an RCA video cable.

### 6. AUDIO input jacks (L2) (DVD/VCR)

- Use to connect external device with an RCA audio cable.

### 7. DV IN jack (L3) (DVD/VCR)

- Use to connect the DV output of external device with a DV cable.

### 8. ● REC button (DVD)

- Press once to start a recording.
- Press repeatedly to start the one-touch timer recording.

### 9. PLAY ► button (DVD)\*

- Press to start or resume playback.

### 10. STOP ■ button (DVD)

- Press to stop playback or recording.
- Press to stop the proceeding timer recording in DVD.

### 11. VCR/DVD indicator

- Lights up when the VCR/DVD output mode is selected.

### 12. VCR/DVD button (DVD/VCR)

- Press to select the component you wish to operate.

### 13. DUBBING button (DVD/VCR)

- Press to start VCR to DVD (DVD to VCR) duplication which you set in the main menu.

### 14. TRACKING ∨ / ▲ buttons (VCR)

- Press to adjust the tracking during playback or in slow motion of the cassette tape.
- While playback is in still mode, you can stabilize the picture.

### 15. Display

- Refer to "FRONT PANEL DISPLAY GUIDE" on page 18.

### 16. Infrared sensor window (DVD/VCR)

- Receive signals from your remote control so that you can control the unit from a distance.

### 17. ● REC button (VCR)

- Press once to start a recording. Press repeatedly to start the one-touch timer recording.

### 18. PLAY ► button (VCR)

- Press to start playback.

### 19. EJECT/STOP ▲/■ button (VCR)

- When the unit is in stop mode, press to remove the cassette tape from the cassette compartment.
- Press to stop cassette tape playback or recording.
- Press to stop the proceeding timer recording in VCR.

### 20. FWD ►► button (VCR)

- Press to rapidly advance the cassette tape, or view the picture rapidly in forward during playback (forward search).

### 21. REV ◀◀ button (VCR)

- Press to rewind the cassette tape, or to view the picture rapidly in reverse during playback (rewind search).

### 22. Power indicator

- This indicator lights up in green when the unit is active and turns off when the unit is in standby mode.

## Rear Panel

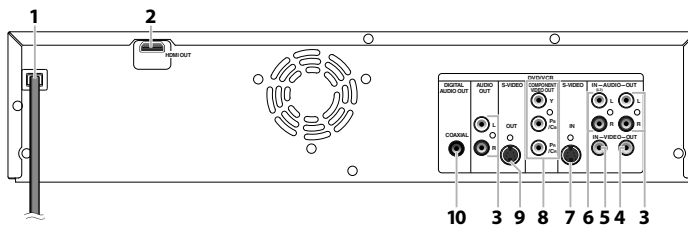

### 1. AC Power Cord

- Connect to a standard AC outlet to supply power to this unit.
- Unplug this cord from the AC outlet to completely shut down the unit.

### 2. HDMI OUT jack

- Use an HDMI cable to connect to a display with an HDMI compatible port.

### 3. AUDIO OUT jacks

- Use to connect a TV monitor, AV receiver or other device with an RCA audio cable.

### 4. VIDEO OUT jack

- Use to connect a TV monitor, AV receiver or other device with an RCA video cable.

### 5. VIDEO IN jack (L1)

- Use to connect external device with an RCA video cable.

### 6. AUDIO IN jacks (L1)

- Use to connect external device with an RCA audio cable.

### 7. S-VIDEO IN jack (L1)

- Use to connect the S-video output of external device with an S-video cable.

### 8. COMPONENT VIDEO OUT jacks

- Use to connect a TV monitor with component video inputs with a component video cable.

### 9. S-VIDEO OUT jack

- Use to connect the S-video input of a TV monitor, AV receiver or other device with an S-video cable.

### 10. COAXIAL DIGITAL AUDIO OUT jack

- Use to connect an AV receiver, Dolby Digital decoder or other device with a coaxial digital input jack with a digital coaxial cable.

### Note

- Do not touch the inner pins of the jacks on the rear panel. Electrostatic discharge may cause permanent damage to the unit.

### Caution on using S-video, component, or HDMI connection for VCR:

- Only the playback audio / video is available with these connections.

# FUNCTIONAL OVERVIEW

## Remote Control

### Installing the Batteries in the Remote Control

Install the batteries (AAx2) matching the polarity indicated inside battery compartment of the remote control.

#### 1 Open the cover.

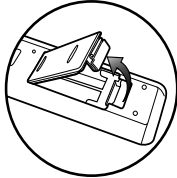

#### 2 Insert batteries.

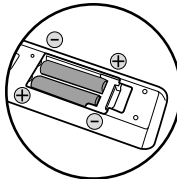

Make sure to match + and - on the batteries to the marks indicated in the battery compartment.

#### 3 Close the cover.

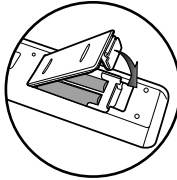

#### Caution:

Never throw batteries into a fire.

#### Note:



- Do not mix different types of batteries such as alkaline and standard (carbon-zinc).
- Lithium or NiCad and NiMH rechargeable batteries are not recommended for use with the remote control.
- Be sure to use AA size batteries.
- Dispose of batteries in a designated disposal area.
- Batteries should always be disposed of with the environment in mind. Always dispose of batteries in accordance with applicable laws and regulations.
- If the remote control does not operate correctly, or if the operating range becomes reduced, replace batteries with new ones.
- When necessary to replace batteries in the remote control, always replace both batteries with new ones. Never mix battery types or use new and used batteries in combination.
- Always remove batteries from remote control if they are dead or if the remote control will not be used for an extended period of time. This will prevent battery acid from leaking into the battery compartment.

### Using a Remote Control

Keep in mind the following when using the remote control:

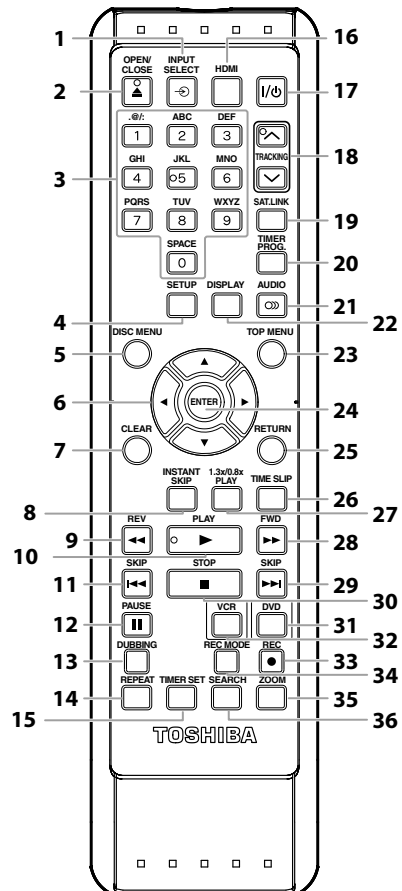
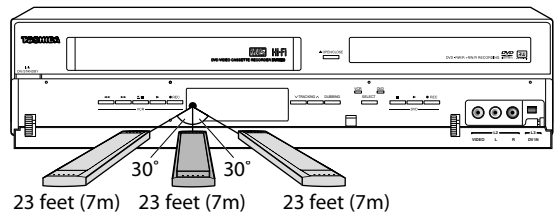
- Make sure that there are no obstacles between the remote control and the infrared sensor window on the unit.
- Remote operation may become unreliable if strong sunlight or fluorescent light is shining on the infrared sensor window of the unit.
- Remote control for different devices can interfere with each other. Avoid using remote control for other device located close to the unit.
- Replace the batteries when you notice a fall off in the operating range of the remote control.
- The maximum operable ranges from the unit are as follows.
  - **Line of sight:** approx. 23 feet (7m)
  - **Either side of the center:** approx. 23 feet (7m) within 30°



- 1. INPUT SELECT  button**
  - Press to select the appropriate input.
- 2. OPEN/CLOSE  button**

**DVD mode:**

  - Press to open or close the disc tray.





**VCR mode:**

  - Press to remove the cassette tape from the cassette compartment.
- 3. Number/Character buttons**
  - Press to enter values for the settings in the main menu.

**DVD mode:**

  - Press to select a title/chapter/track/file on display.
  - Press to enter title names.

**VCR mode:**

  - Press to start the index/time search.
- 4. SETUP button**
  - Press to display the main menu.
  - During DVD playback, press and hold for more than 3 seconds to switch the progressive scanning mode to the interlace mode. (Though  appears, the output mode switches to the interlace and "4:3 1:1" will be displayed on the front panel display briefly.)
- 5. DISC MENU button (DVD)**
  - Press to display the disc menu. To change original and playlist on the TV screen.
- 6. Cursor  /  /  /  buttons**
  - Press to select items or settings.
- 7. CLEAR button**

**DVD mode:**

  - Press to clear the password once entered, to cancel the programming for CD, to clear the selecting marker number in the display menu, etc.



**VCR mode:**

  - Press to reset the tape counter.
- 8. INSTANT SKIP button (DVD)**
  - During playback, press to skip 30 seconds.
- 9. REV  button**

**DVD mode:**

  - During playback, press to fast reverse playback.
  - When playback is in pause, press to slow reverse playback.





**VCR mode:**

  - During playback, press to view the picture rapidly in reverse.
  - Press to fast reverse the cassette tape in stop mode.
- 10. PLAY  button**
  - Press to start playback or resume playback.
- 11. SKIP  button (DVD)**
  - During playback, press to return to the beginning of the current chapter, track or file.
  - During playback, press twice in quick succession to skip to the previous chapter or track.
  - When playback is in pause, press repeatedly to reverse the playback step by step.
- 12. PAUSE  button**
  - Press to pause playback or recording.
- 13. DUBBING button**
  - Press to start VCR to DVD (DVD to VCR) duplication which you set in the main menu.
- 14. REPEAT button**

**DVD mode:**

  - Press to select the repeat mode.

**VCR mode:**

  - Press to set or release the Auto Repeat Playback. In the Auto Repeat Playback mode, tape is played to its end, the tape will rewind to the beginning and start playback itself.
- 15. TIMER SET button**
  - Press to set the unit in the timer standby mode. In the timer standby mode, press to cancel the mode and to turn the unit on.
- 16. HDMI button (DVD)**
  - Press to set the HDMI video resolution.
- 17. I/O  ON/STANDBY button**
  - Press to turn on the unit, or to turn the unit into the standby mode. (To completely shut down the unit, you must unplug the AC power cord).
- 18. TRACKING  /  buttons (VCR)**
  - Press to adjust the tracking during playback or in slow motion of the cassette tape.
  - While playback is in still mode, you can stabilize the picture.
- 19. SAT.LINK button**
  - Press to turn the unit into the satellite link standby mode.
  - In the satellite link standby mode, press to cancel the mode and to turn the unit on.
- 20. TIMER PROG. button**
  - Press to display the timer programming list.
- 21. AUDIO  button**

**DVD mode:**

  - During playback, press to display the audio menu.



**VCR mode:**

  - During the playing of a HiFi video tape, press to change the audio out setting to HiFi or mono.
- 22. DISPLAY button**
  - Press to display the display menu on or off.
- 23. TOP MENU button (DVD)**
  - Press to display the title list.
- 24. ENTER button**
  - Press to confirm or select menu items.
- 25. RETURN button**
  - Press to return to the previous displayed menu screen.
- 26. TIME SLIP button (DVD)**
  - Press once to start recording the TV program you are watching. Press again to watch the content being recorded from the beginning while recording continues. (VR mode DVD-RW with the recording mode of LP, EP or SLP only)
- 27. 1.3x/0.8x PLAY button (DVD)**
  - During playback, press to play back in a slightly faster/slower speed while keeping the sound output.
- 28. FWD  button**

**DVD mode:**

  - During playback, press to fast forward playback.
  - When playback is in pause, press to slow forward playback.





**VCR mode:**

  - During playback, press to view the picture rapidly in forward.
  - Press to fast forward the cassette tape in stop mode.
  - When playback is paused, press to view the cassette tape in slow motion.
- 29. SKIP  button (DVD)**
  - During playback, press to skip to the next chapter, track or file.
  - When playback is in pause, press repeatedly to forward the playback step by step.
- 30. STOP  button**
  - Press to stop playback or recording.

**DVD mode:**

  - Press to exit from the title list.
- 31. DVD button**
  - Press to select the DVD output mode.
- 32. VCR button**
  - Press to select the VCR output mode.
- 33. REC  button**
  - Press once to start a recording.
  - Press repeatedly to start the one-touch timer recording.
- 34. REC MODE button**
  - Press to switch the recording mode.
- 35. ZOOM button (DVD)**
  - During playback, press to enlarge the picture on the TV screen.
- 36. SEARCH button (VCR)**
  - Press to call up the index or time search menu.

## Note

- If you turn off this unit, [OPEN/CLOSE ] on the remote control is not available. Be sure to use [ OPEN/CLOSE] or [EJECT/STOP / ] on the unit.

# THE VCR / DVD RECORDER SWITCHING

Because this product is a combination of a VCR and a DVD recorder, you must select first which component you wish to operate with [VCR/DVD].

## DVD mode

Press [DVD] on the remote control.  
(Verify that the DVD indicator is lit.)

## VCR mode

Press [VCR] on the remote control.  
(Verify that the VCR indicator is lit.)

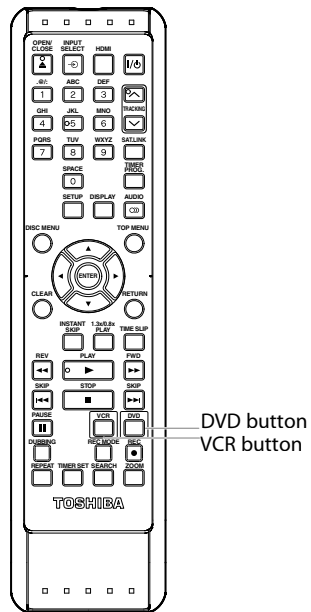
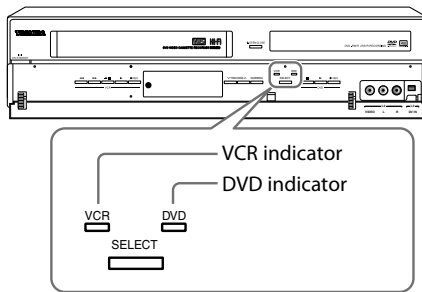

## Note

- You cannot switch to the other mode in the timer-standby mode.
- Playback will stop when you change the output mode.

# GUIDE TO ON-SCREEN DISPLAYS AND MENUS

This unit uses the following on-screen displays and menus to guide you to the easy operations. The on-screen displays give you the information on the loaded disc, the disc/file in playback, or the HDMI status, etc. The menus allow you to change the various kinds of settings for playing back, recording, or editing to suit your preference.

## On-Screen Display / Menu

The on-screen display changes in the following order as you press [DISPLAY].

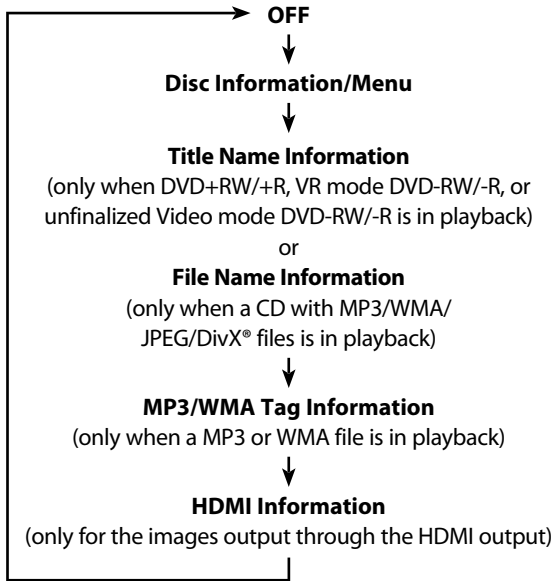

## Disc Information / Menu

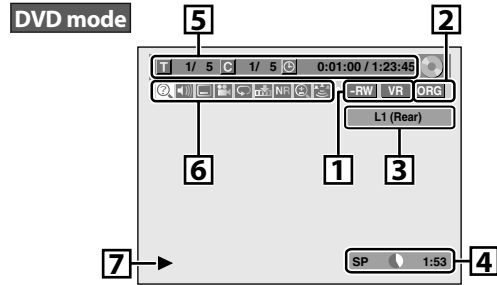

\* This is an example screen only for explanation.

1. Indicates a disc type and format mode.
2. Indicates a type of titles for VR mode DVD-RW .
3. Indicates a selected external input mode.
4. Indicates a recording mode and possible recording time left.
5. Indicates a title number / total number of titles, chapter number /total number of chapters, elapsed time and total time of disc playback.
6. Each icon means:
  - : Search
  - : Marker
  - : Audio
  - : Noise Reduction / Black Level
  - : Subtitle
  - : Zoom
  - : Angle
  - : Surround
  - : Repeat
7. Indicates an operation status.

### Note

- In some descriptions on this manual, only one disc type is indicated as an example.

# GUIDE TO ON-SCREEN DISPLAYS AND MENUS

## VCR Information

VCR mode

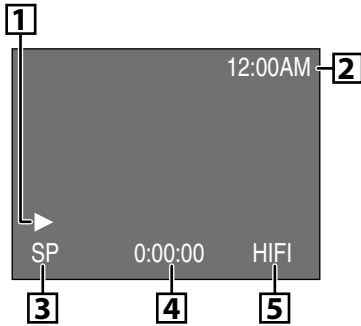

\* This is an example screen only for explanation.

1. Indicates current video status.
2. Indicates the current time.
3. Indicates a recording or playing back mode.
4. Indicates a tape counter.
5. Audio status of the current cassette tape.

### Note

- VCR information does not appear on the screen when the unit is connected by an HDMI, Component or S-Video cable, except during the playback.

## HDMI Information

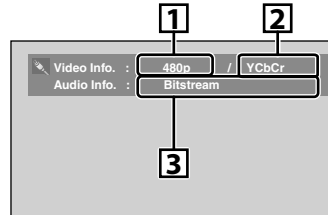

1. Indicates the resolution of the HDMI output image.
  2. Indicates the HDMI video format.
  3. Indicates the HDMI audio format.
- "--" will be displayed, when it does not have any information.

## Title/File Name Information

Title name information

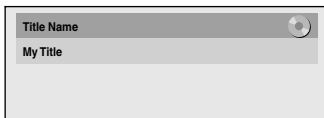

File name information

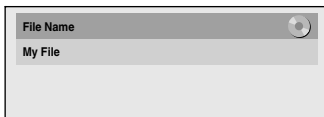

## MP3/WMA Tag Information

- First, track name will be displayed.

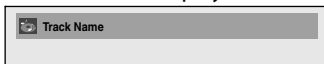

- If you press **[DISPLAY]** one more time, artist name will be displayed.



- If you press **[DISPLAY]** one more time, album name will be displayed.

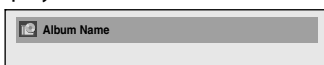

- If there is no artist, track or album name, "Not Available" will be displayed.



## Main Menu

Press [SETUP] to display the main menu. Then use [▲ / ▼] to select a menu and press [ENTER] to display the menu. These menus provide entries to all main functions of the unit.

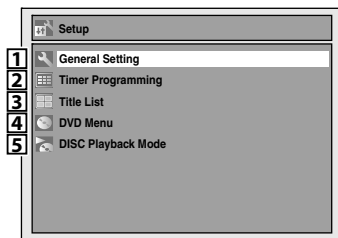

### 1. General Setting:

To go to general setting menu.

### 2. Timer Programming:

To program a timer recording.

### 3. Title List:

To call up the title list.

### 4. DVD Menu:

To set up the DVD setting.

### 5. DISC Playback Mode:

To set up the disc playback setting.

- "DISC Playback Mode" is available only when an audio CD, a CD-RW/-R with MP3 / WMA / JPEG / DivX® files is inserted into the unit.

## General Setting Menu

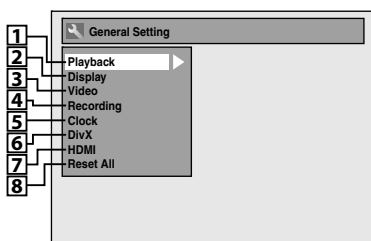

### 1. Playback:

To set up the unit to play back discs as you prefer.

### 2. Display:

To set up the OSD screen as you prefer.

### 3. Video:

To set up the video setting.

### 4. Recording:

To set up the unit to record to discs as you prefer.

### 5. Clock:

To set up the clock of the unit as you need.

### 6. DivX:

To set up the setting for the DivX® playback.

### 7. HDMI:

To set up the HDMI connection setting.

### 8. Reset All:

To reset the setting to the factory default.

## DVD Menu / DISC Playback Mode

<DVD Menu menu>

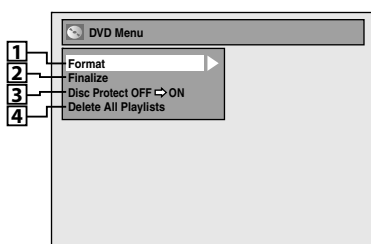

<DISC Playback Mode menu>

When an Audio CD is inserted:

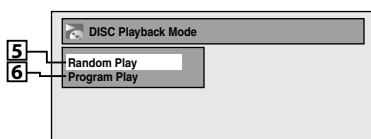

When a JPEG / MP3 / WMA disc is inserted:

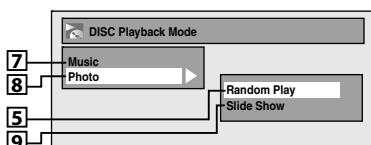

### 1. Format (DVD-RW, DVD+RW only):

Allows you to format the disc.

### 2. Finalize:

Allows you to finalize a disc containing recorded titles.

### 3. Disc Protect (VR mode DVD-RW, DVD+RW/+R only):

Allows you to protect a disc from accidental editing or recording.

### 4. Delete All Playlists (VR mode DVD-RW only):

Allows you to delete playlist.

### 5. Random Play:

Allows you to activate the random playback feature.

### 6. Program Play: (Audio CD only)

Allows you to activate the program playback feature.

### 7. Music:

Allows you to make settings for MP3 / WMA playback.

### 8. Photo:

Allows you to make settings for JPEG playback.

### 9. Slide Show: (JPEG files only)

Allows you to select the display time of the slide show mode.

# FRONT PANEL DISPLAY GUIDE

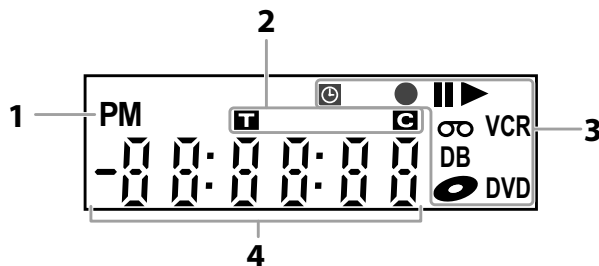

1.

**PM** : Appears in the afternoon with the clock display.

## 2. Title / track and chapter mark

**T** : Appears when indicating a title / track number.

**C** : Appears when indicating a chapter number.

## 3. Current status of the unit

**||** : Appears when playback is paused.

**▶** : Appears when playing back a disc.

**⌚** : Appears when the timer programming or OTR has been set and is proceeding.

: Flashes when all timer recordings have been finished.

**●** : Appears during recording process.

: Flashes when a recording pauses.

**○** : Appears when this unit is in DVD output mode and a disc is in the unit.

: Appears during duplication process.

**∞** : Appears when this unit is in VCR output mode and a cassette tape is in the unit.

: Appears during duplication process.

**VCR** : Appears when this unit is in VCR output mode.

: Appears when the timer recording is proceeding in VCR.

: Appears when VCR is in the timer recording standby mode.

: Flashes when a program cannot be performed for some reasons.

**DVD** : Appears when this unit is in DVD output mode.

: Appears when the timer recording is proceeding in DVD.

: Appears when DVD is in the timer recording standby mode.

: Flashes when a program cannot be performed for some reasons.

**DB** : Appears during VCR to DVD duplication process.

: Appears during DVD to VCR duplication process.

## 4. Displays the following

- Elapsed playback time
- Current title / chapter / track / file number
- Recording time / remaining time
- Clock
- Selected external input position
- Remaining time for one-touch timer recording
- Selected HDMI video resolution

## Display Message

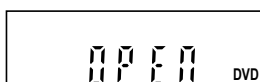

Appears when the disc tray is opening.

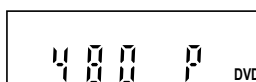

Appears when HDMI video resolution (480p) is selected.

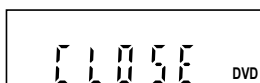

Appears when the disc tray is closing.

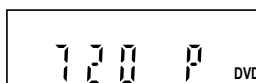

Appears when HDMI video resolution (720p) is selected.

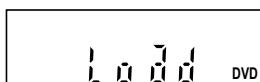

Appears when a disc is loaded on the disc tray.



Appears when HDMI video resolution (1080i) is selected.

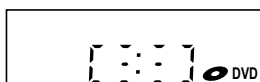

Appears when data is being recorded on a disc.

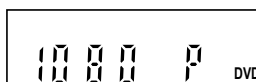

Appears when HDMI video resolution (1080p) is selected.

**Read this first:**

- 1) Disconnect the AC power cords of the devices from the AC outlet.
- 2) Make the connection as illustrated below.
- 3) After making all the connections, connect the AC power cords of the devices.

• Connect this unit directly to the TV. If the RCA audio/video cables are connected to a VCR, DVD playback pictures may be distorted due to the copy protection system.

## Connecting to an External Tuner

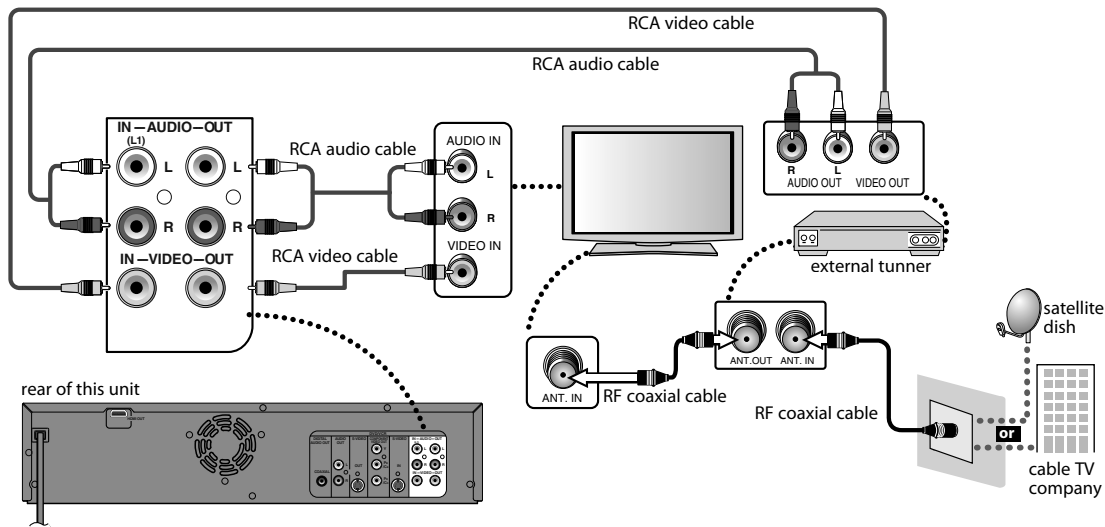

After making the connection as described above, make sure to select the appropriate input type by following the steps on page 27.

**Note**

- Required cables and connecting methods differ depending on the cable/satellite box. For more information, please contact your cable/satellite provider.
- Instead of using VIDEO OUT jack of this unit, you can also use S-VIDEO OUT jack, COMPONENT VIDEO OUT jacks or HDMI OUT jack for connecting to your TV.

**With this setup:**

- You can record any unscrambled channel by selecting the channel on the cable/satellite box. Be sure that the cable/satellite box is turned on.
- **You cannot record one channel while watching another channel.**

**Supplied cables used in this connection are as follows:**

- RCA audio cable (L/R) x 1
- RCA video cable x 1

Please purchase the rest of the necessary cables at your local store.

## TV Connection Overview

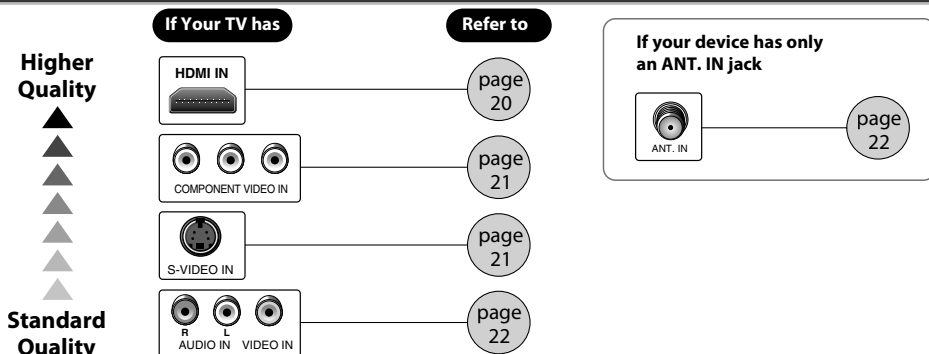

# CONNECTIONS

## Connecting to a TV with an HDMI Compatible Port

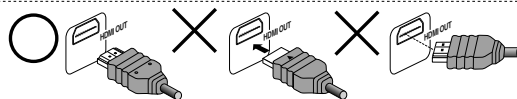
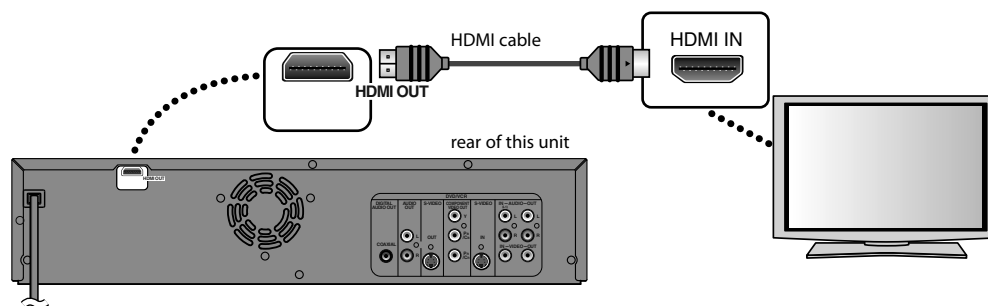

Do not tilt the connector when inserting it into the HDMI jack, and make sure the shapes of the jack and the connector are matched.

### No supplied cables are used in this connection:

Please purchase the necessary cables at your local store.

## HDMI Video Resolution and Actual Output Signals

Press **[HDMI]** to select the HDMI video resolution. The video resolution changes as follows every time **[HDMI]** is pressed.

Front Panel Display	Video Output Signal
480P	480 Progressive
Press [HDMI]	↓
720P	720 Progressive
Press [HDMI]	↓
1080i	1080 interlaced
Press [HDMI]	↓
1080P	1080 Progressive
Press [HDMI]	

### Copyright protection system

To play back the digital video images of a DVD via an HDMI connection, it is necessary that both the player and the display device (or an AV amplifier) support a copyright protection system called HDCP (high-bandwidth digital content protection system). HDCP is copy protection technology that comprises data encryption and authentication of the connected AV device. This unit supports HDCP. Please read the operating instructions of your display device (or AV amplifier) for more information.

\*HDMI: High Definition Multimedia Interface

- The HDMI mode that is not supported by display device will be skipped.

### Note

- Some devices with an HDMI input may not operate properly with this unit.
- When using an HDCP-incompatible display device, the image will not be viewed properly.
- Among the devices that support HDMI, some devices can control other devices via the HDMI connector; however this unit cannot be controlled by another device via the HDMI connector.
- The audio signals from the HDMI connector (including the sampling frequency, the number of channels and bit length) may be limited by the device that is connected.
- Among the monitors that support HDMI, some do not support audio output (for example, projectors). In connections with device such as this unit, audio signals are not output from the HDMI output connector.
- When this unit's HDMI connector is connected to a DVI-D compatible monitor (HDCP compatible) with an HDMI-DVI converter cable, the signals are output in digital RGB.
- When the power failure occurs, or when you unplug the unit, some problems in the HDMI setting might occur. Please check and set the HDMI setting again.
- HDMI video resolution cannot be changed when the unit is in VCR mode.

## Connecting to a TV with Component Video Input Jacks

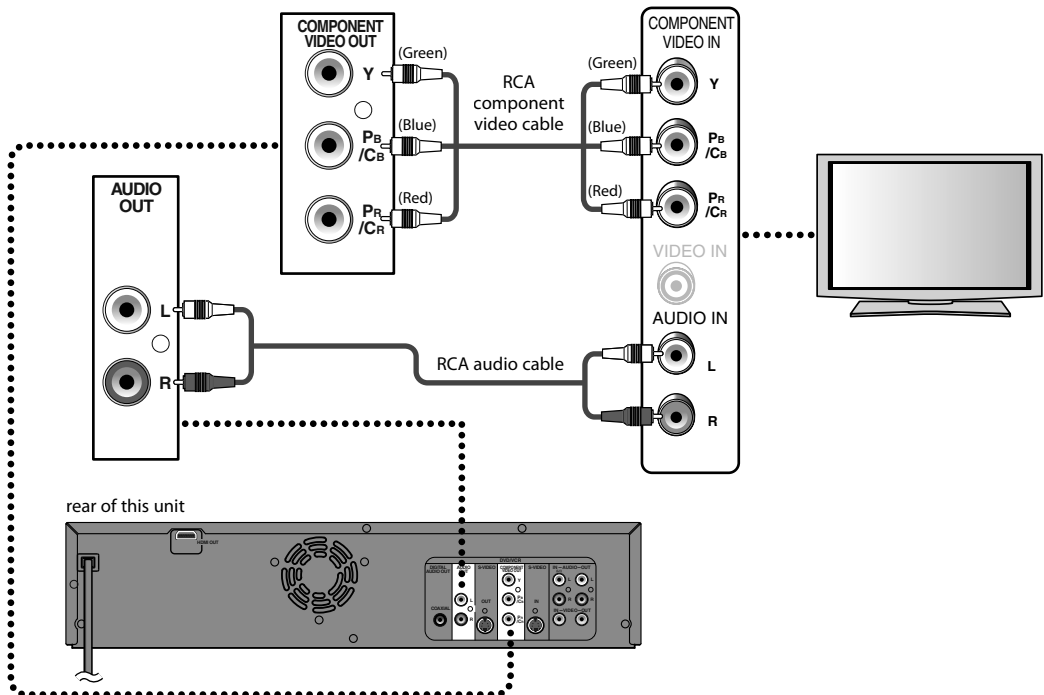

### Supplied cables used in this connection are as follows:

- RCA audio cable (L/R) x 1
- Please purchase the rest of the necessary cables at your local store.

## Connecting to a TV with an S-Video Input Jack

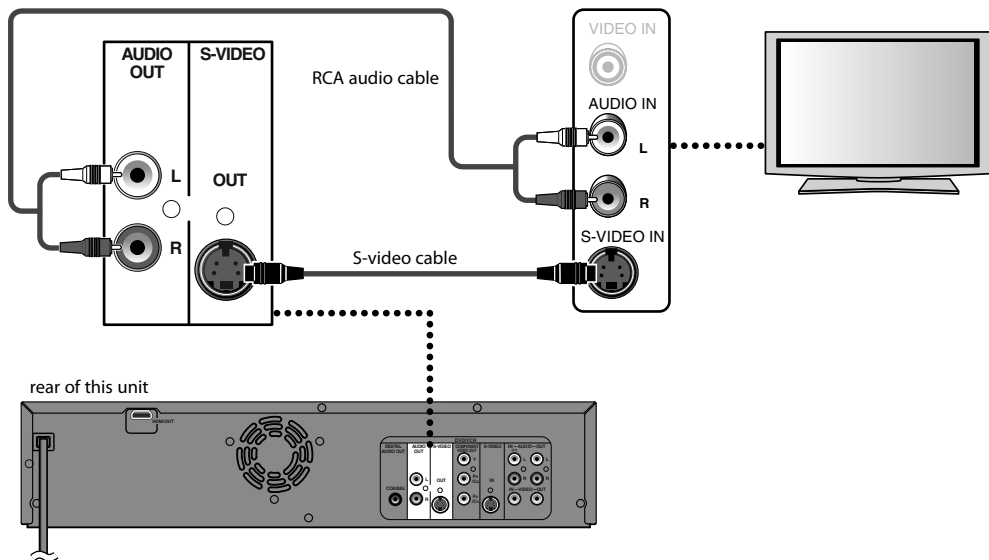

### Supplied cables used in this connection are as follows:

- RCA audio cable (L/R) x 1
- Please purchase the rest of the necessary cables at your local store.

# CONNECTIONS

## Connecting to a TV with Audio / Video Input Jacks

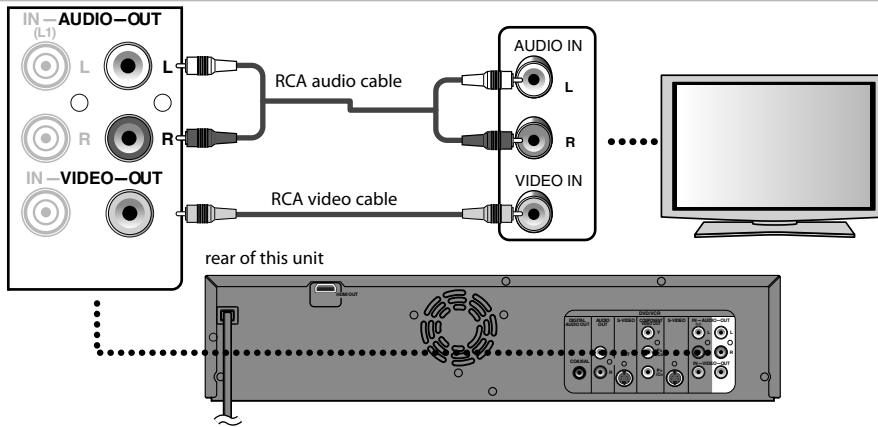

### Supplied cables used in this connection are as follows:

- RCA audio cable (L/R) x 1
- RCA video cable x 1

## Connecting to a TV without Audio / Video Input Jacks

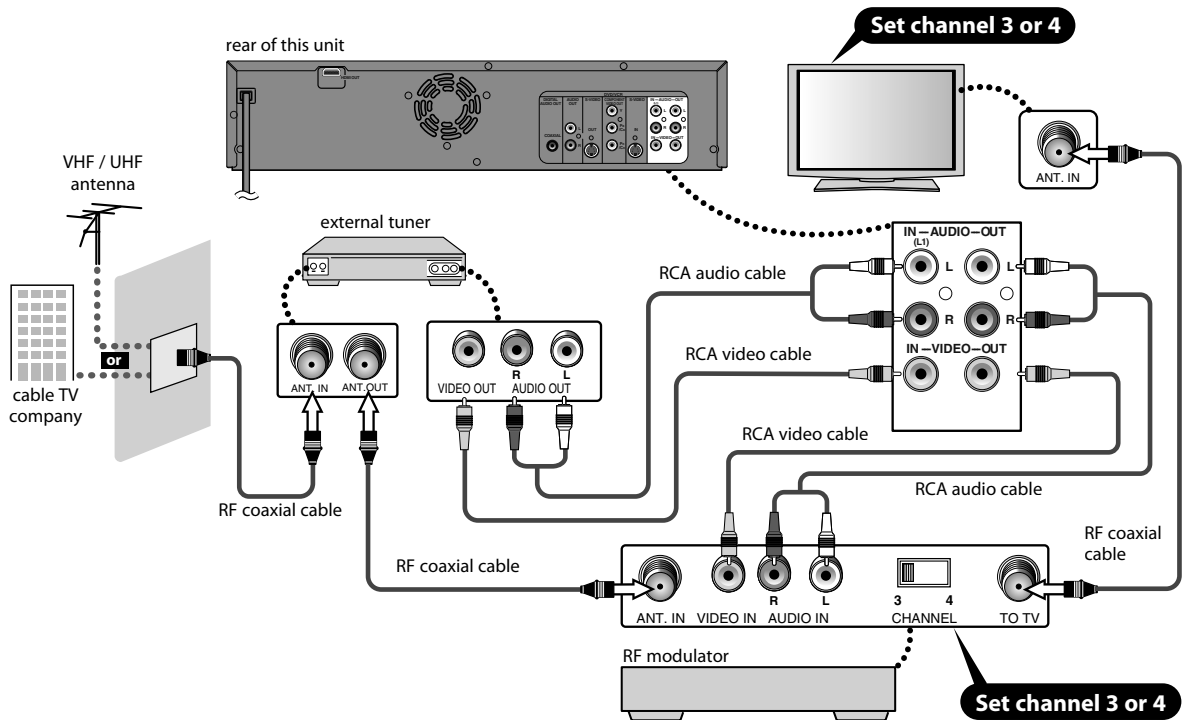

### Supplied cables used in this connection are as follows:

- RCA audio cable (L/R) x 1
- RCA video cable x 1

Please purchase the rest of the necessary cables at your local store.

### Note

- RF modulator is not supplied with this unit. You need to purchase it at your local store.
- The quality of picture may become poor if this unit is connected to an RF modulator.

## Digital Audio Connection

### Coaxial Cable Connection

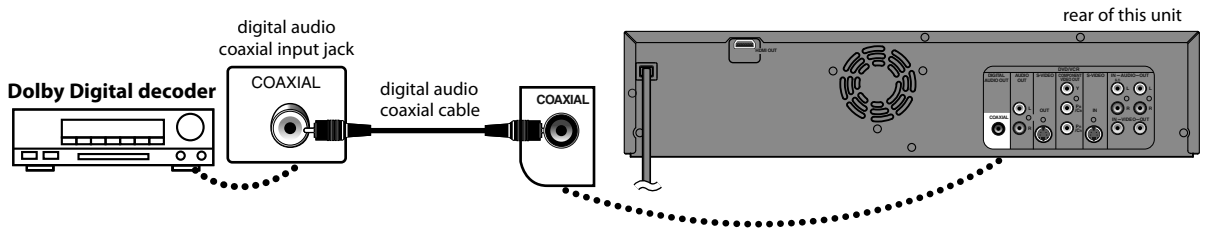

### HDMI Audio Connection

AV receiver / amplifier with an HDMI input jack

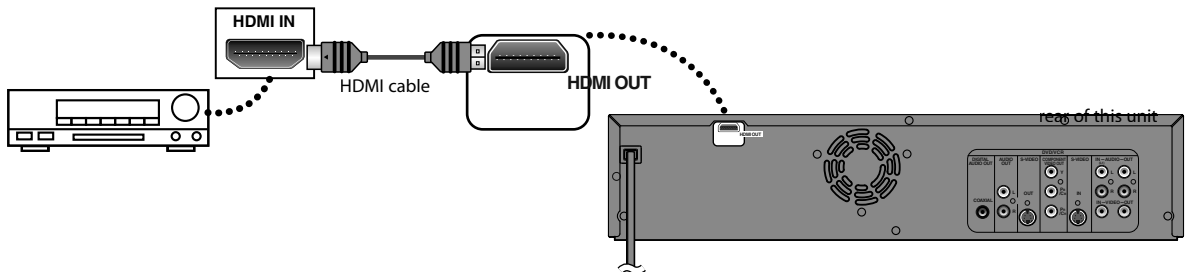

To set up "HDMI Audio", refer to pages 87 and 97-98.

**No supplied cables are used in these connections:**

Please purchase the necessary cables at your local store.

### Multi Channel Digital Audio Setting

To set up "Dolby Digital", refer to pages 86 and 88-90.

Audio Format (disc)	Setting in the Setup Menu		Actual Audio Output	
	Dolby Digital Setting of this unit (refer to page 90)	DTS Setting of this unit (refer to page 90)	HDMI Out	Digital Audio Out
Dolby Digital	Stream	—	Dolby Digital	Dolby Digital
	PCM	—	2 channel PCM	2 channel PCM
DTS	—	ON	DTS	DTS
	—	OFF	No output	No output
LPCM	Stream	ON	2 channel PCM	2 channel PCM
	PCM	OFF	2 channel PCM	2 channel PCM

## Note

- The audio source on a disc in a Dolby Digital multi channel surround format cannot be recorded as digital sound by an MD or DAT deck.
- By connecting this unit to a Dolby Digital decoder, you can enjoy high-quality Dolby Digital multi channel surround sound as heard in the movie theaters.
- By connecting this unit to the DTS decoder, you can enjoy Multi-channel Surround System which reproduces the original sound as truthfully as possible. Multi-channel Surround System is developed by the DTS, Inc.
- Playing back a DVD using incorrect settings may generate noise distortion and may also damage the speakers.
- For audio CD and MP3 / WMA files, 2 channel PCM will be output regardless of the "Dolby Digital" setting.  
If the connected device is not compatible with HDMI BITSTREAM, audio will be output as PCM even if you select "Stream" in "Dolby Digital" setting (Refer to page 90).
- The audio signals from the HDMI connector (including the sampling frequency, the number of channels and bit length) maybe limited by the device that is connected.
- Among the monitors that support HDMI, some do not support audio output (for example, projectors). In connections with device such as this unit, audio signals are not output from the HDMI output connector.
- If the connected equipment is not compatible with HDMI BITSTREAM, DTS sound will not be output.

## 2 Channel Analog Audio Connection

### Stereo system

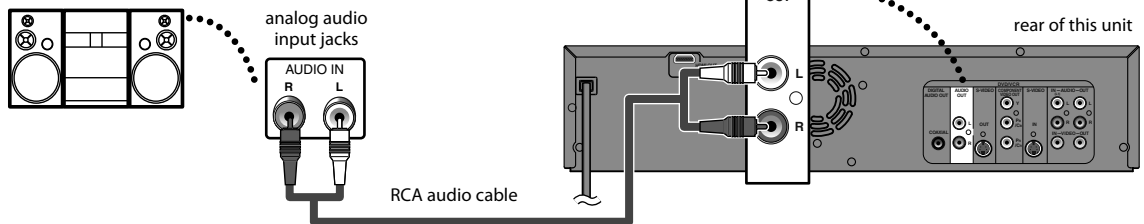

### Supplied cables used in this connection are as follows:

- RCA audio cable (L/R) x 1



# INITIAL SETTING

When you turn on this unit for the first time, you need to follow these steps after you have completed all the connections.

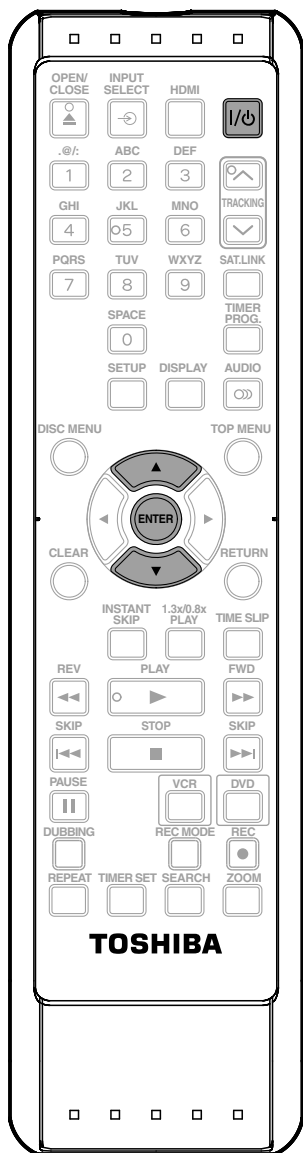

**1** After you have made all the necessary connections, press [I/ON/STANDBY] to turn on the unit.

**2** Turn on your TV.

**3** Press the button on the TV's remote control that accesses the external input channel. It may be labeled "SOURCE", "AV" or "SELECT" (refer to your TV's user manual). Or press "2" on the TV's remote control, then press channel down button repeatedly until you see the "Initial Setting" menu.

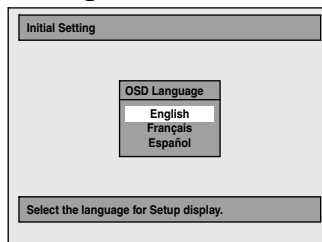

**4** Use [▲ / ▼] to select your desired language, then press [ENTER] to set language.

**5** Press [ENTER] to activate "Clock Setting".

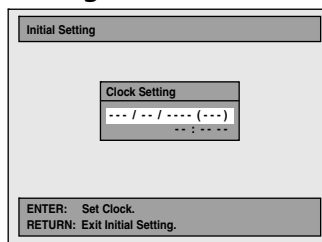

**6** Proceed to step 4 in "Clock Setting" on page 26.

# SETTING THE CLOCK

Set the clock before you try the timer programming.

## Clock Setting

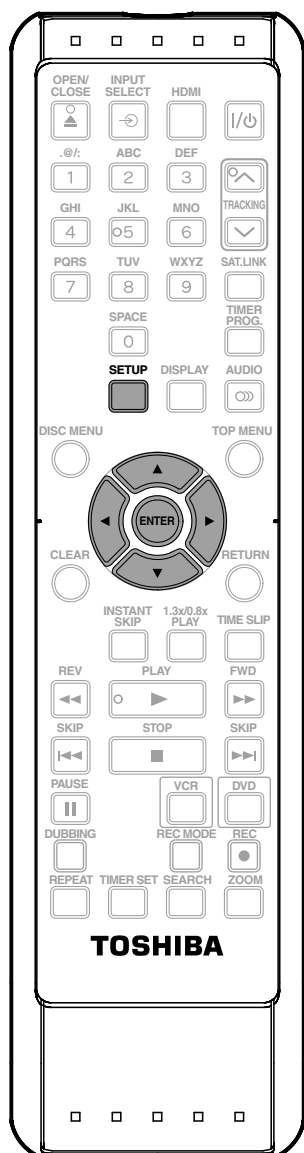

**1** Press [SETUP] and use [▲ / ▼] to select "General Setting", then press [ENTER].

**2** Use [▲ / ▼] to select "Clock", then press [ENTER].  
"Clock" menu will appear.

**3** Use [▲ / ▼] to select calendar or time, then press [ENTER].

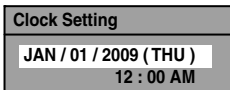

**4** Use [◀ / ▶] to select an item to set, and use [▲ / ▼] to select the contents to suit your preference, then press [ENTER].

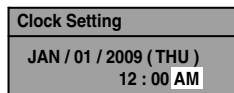

Your setting will be activated.  
The clock start counting when you press [ENTER].

**5** Press [SETUP] to exit.

### Note

- Your clock setting will be lost if either there is a power failure or this unit has been unplugged for more than 30 seconds.
- For setting the day, year, hour and minute, **[the Number buttons]** can also be used.
- You can set the built-in calendar from the year 2008 up to 2058.

# SETTINGS FOR THE VIDEO INPUT

You must let the unit know which video input jack you are using before making a recording.

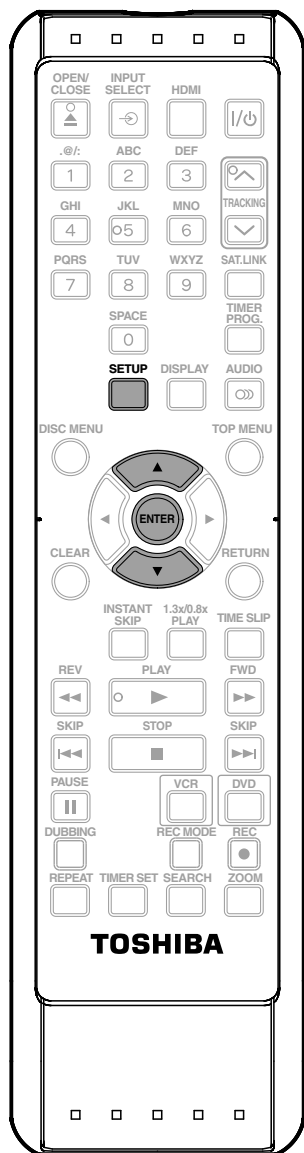

- 1** Press [SETUP].
- 2** Use [▲ / ▼] to select “General Setting”, then press [ENTER].
- 3** Use [▲ / ▼] to select “Video”, then press [ENTER].
- 4** Use [▲ / ▼] to select “Select Video”, then press [ENTER].
- 5** Use [▲ / ▼] to select the input jack type to connect, then press [ENTER].  
If you want to use VIDEO IN jack, select “Video In”, then press [ENTER].  
If you want to use S-VIDEO IN jack, select “S-Video In”, then press [ENTER].
- 6** Press [SETUP] to exit.

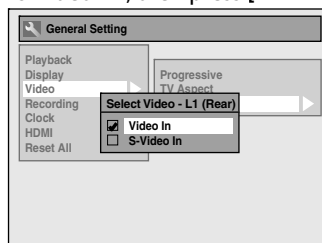

# FORMATTING A DISC

## Choosing the Recording Format of a Brand-New DVD-RW



When inserting a brand-new DVD-RW or DVD+RW, the unit automatically starts to initialize the disc. DVD+RW will always be formatted in +VR mode, and DVD-RW will be formatted either video or VR mode according to the recording format mode setting of the unit. Before insert a brand-new DVD-RW, you need to set the recording format to the desired mode. You can also manually format a DVD-RW once it has been used.

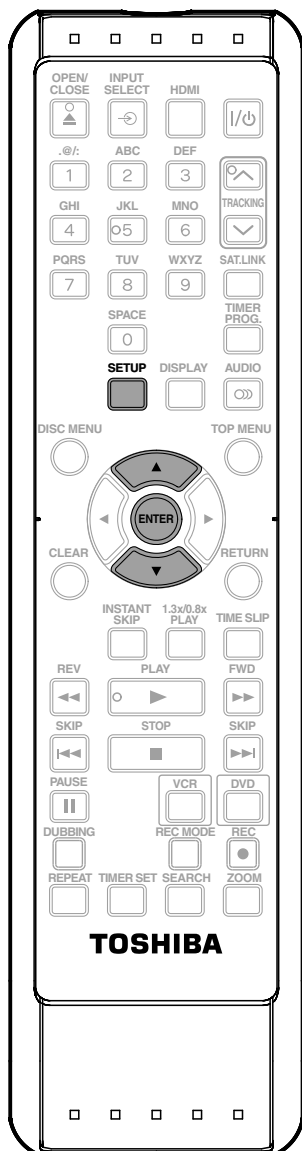

**1** Press [SETUP].

**2** Use [▲ / ▼] to select “DVD Menu”, then press [ENTER].

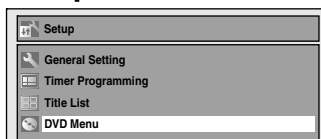

**3** Use [▲ / ▼] to select “Format”, then press [ENTER].



**4** Use [▲ / ▼] to select “Format Mode”, then press [ENTER].

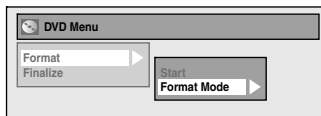

**5** Use [▲ / ▼] to select “Video mode” or “VR mode”, then press [ENTER].

**6** Press [SETUP] to exit.

**7** Insert a brand-new disc.  
Formatting will start.



**8** Formatting is completed.  
“100%” is indicated.

### Note

- The recording format setting is effective only for DVD-RW. You cannot change the recording format for a DVD-R and DVD+RW/+R.
- You cannot mix two formats on one DVD-RW disc. If you insert a disc that has been formatted before, the recording format is not changed if you select another format in the “Setup” menu only. To reformat a disc (change disc format type), refer to “Reformatting a Disc Manually” on page 29.

## Reformatting a Disc Manually



If you are using a DVD-RW or DVD+RW, you can format the disc by performing "Format". You can format DVD-RW for either video mode recording or VR mode recording. DVD+RW can be format in order to erase all content of the disc.

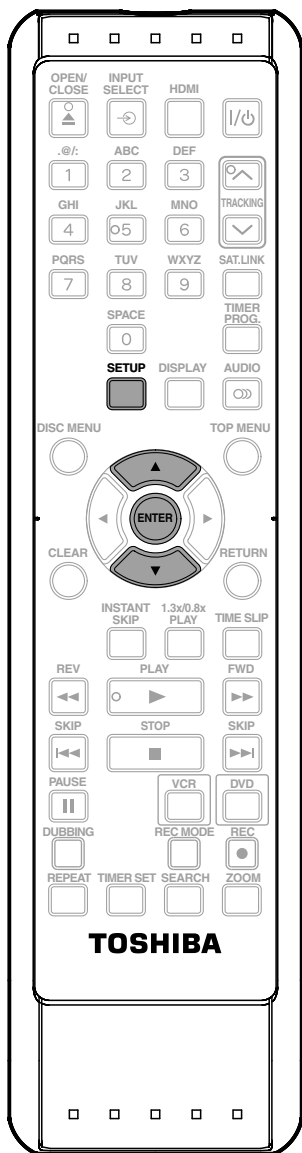

### Insert a recordable disc.

**1** Press [SETUP].

**2** Use [▲ / ▼] to select "DVD Menu", then press [ENTER].

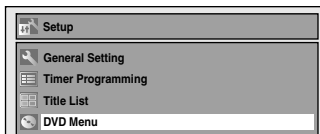

**3** Use [▲ / ▼] to select "Format", then press [ENTER].  
e.g.) VR mode DVD-RW

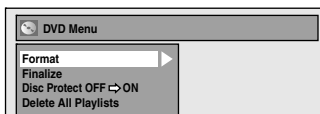

**4** Use [▲ / ▼] to select "Start", then press [ENTER].

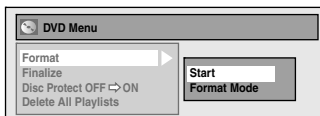

Selection menu will appear and prompt you to confirm.

- For DVD+RW, use [▲ / ▼] to select "Yes", then press [ENTER].

**5** Use [▲ / ▼] to select "Yes", then press [ENTER].

Formatting will start.

If you want to cancel formatting, select "No".

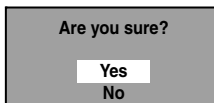

**6** Formatting is completed.  
"100%" is indicated.



### Note

- When you reformat the disc, the contents of the disc are erased.
- For DVD-RW, make sure that the recording format is set to the desired mode. (See steps 1 to 6 in "Choosing the Recording Format of a Brand-New DVD-RW" on page 28.)
- This unit may not be able to reformat a disc that is not previously formatted by this unit (e.g. DVD disc formatted by PC or another recorder).

# SETTING A DISC TO PROTECT



To prevent accidental recording, editing or erasing the titles, you can protect them from "DVD Menu" menu.

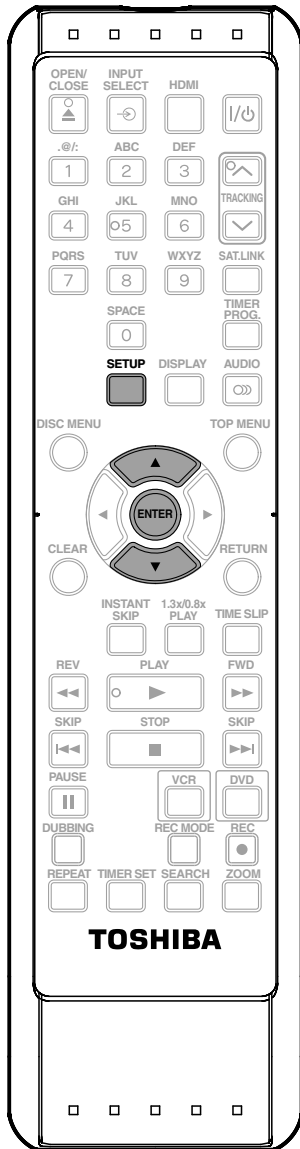

- 1 Press [SETUP].
- 2 Use [▲ / ▼] to select "DVD Menu", then press [ENTER].
- 3 Use [▲ / ▼] to select "Disc Protect OFF → ON", then press [ENTER].  
e.g.) VR mode DVD-RW

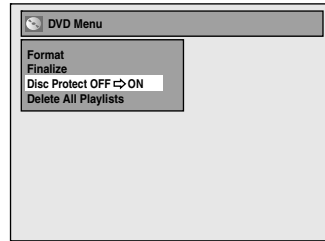

- 4 Use [▲ / ▼] to select "Yes", then press [ENTER].

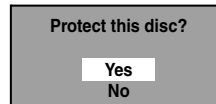

A disc will be protected.

**This operation may take awhile to be completed.**

## Note

### To cancel the disc protect:

- When you insert a disc protected with this unit, "Disc Protect ON → OFF" will appear instead of "OFF → ON".



To release the protection for the disc, select "Disc Protect ON → OFF" at step 3, then follow rest of the procedures.

## Auto Finalizing



You can finalize discs automatically using this function. You can use this function to finalize discs after finishing timer recordings and at the end of the disc space.

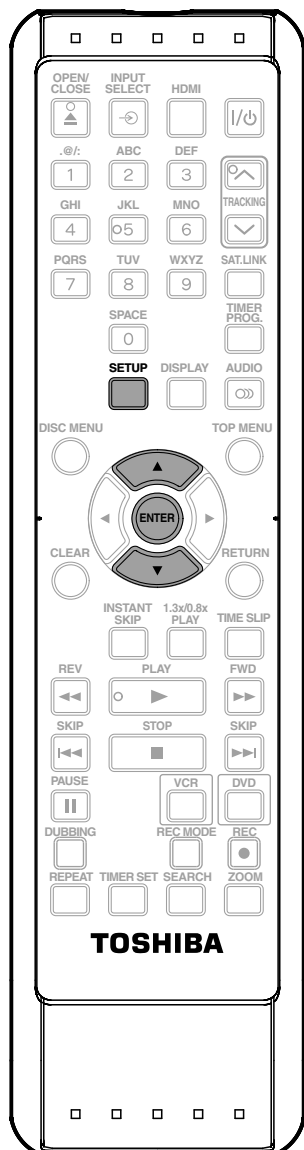

**1** Press [SETUP] and use [▲ / ▼] to select “General Setting”, then press [ENTER].

“General Setting” menu will appear.

**2** Use [▲ / ▼] to select “Recording”, then press [ENTER].

“Recording” menu will appear.

**3** Use [▲ / ▼] to select “Auto Finalize”, then press [ENTER].

**4** Use [▲ / ▼] to select “Disc Full” or “End of Timer Rec”, then press [ENTER].

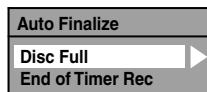

**5** Use [▲ / ▼] to select “ON”, then press [ENTER].

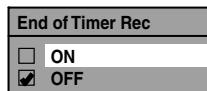
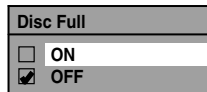

Your setting will be activated.

**6** Press [SETUP] to exit.

### Note

- This function is not available after finishing daily or weekly program recording.

# PLAYING THE DISCS IN OTHER DVD PLAYERS

## Finalizing a Disc



You will need to finalize discs to play back on other DVD players.

Finalizing may take several minutes up to an hour.

Since the process of the finalization fills empty space of the disc, a shorter recording period on the disc will require a longer time period for finalization. Do not unplug the power cord during finalization.

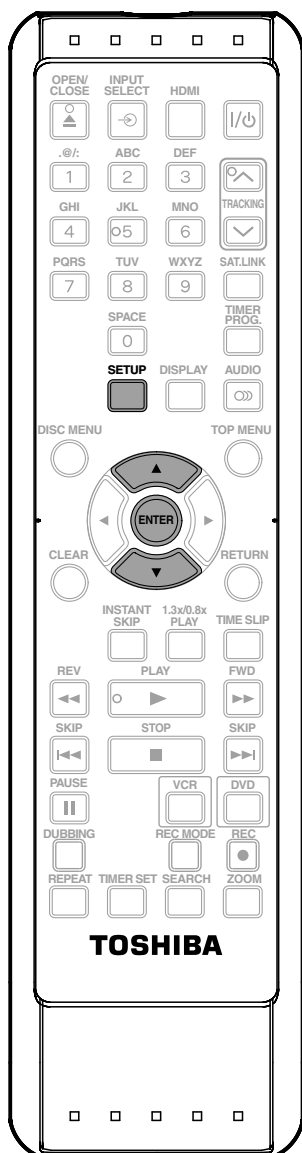

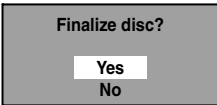
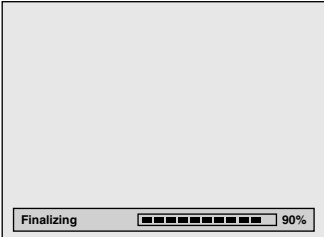
- 1** Press [SETUP].
- 2** Use [▲ / ▼] to select "DVD Menu", then press [ENTER].  
"DVD Menu" menu will appear.
- 3** Use [▲ / ▼] to select "Finalize", then press [ENTER].
- 4** Use [▲ / ▼] to select "Yes", then press [ENTER].  
e.g.) VR mode DVD-RW  
  
Finalizing will start.  
  
This operation may take awhile to be completed.
- 5** Finalizing is completed.



**Note**

- Finalizing a disc in video mode and +VR mode automatically creates a title menu.
- After you finalize the DVD+RW, you can call up the title list by pressing **[TOP MENU]**, or you can call up the title menu by pressing **[DISC MENU]**.
- Even after DVD+RW is finalized, you can still record or edit. After you finalize DVD-RW/-R or DVD+R, you cannot edit or record anything else on that disc.
- If you insert a DVD-RW finalized with this unit, "Undo Finalization" will appear instead of "Finalize" at step 3.
- To release the finalization of the DVD-RW disc, select "Undo Finalization" at step 3.

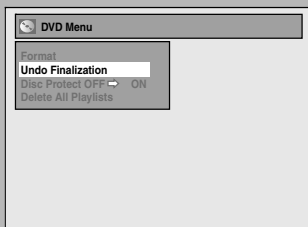

- To undo the finalization of the DVD+RW, make an additional recording onto the disc.
- DO NOT power off during finalizing. This may result in a malfunction.
- For DVD+RW, if you have added or deleted chapters, or made chapters hidden, you must finalize the disc before being able to see those effects on other units. To play back discs other than DVD+RW on other DVD players, you will need to finalize.

**To cancel finalizing...  
(DVD-RW only)**

Press **[STOP ■]** during the finalizing is in progress. Use **[▲ / ▼]** to select "Yes", then press **[ENTER]**. Finalizing is canceled and the unit switches to stop mode.

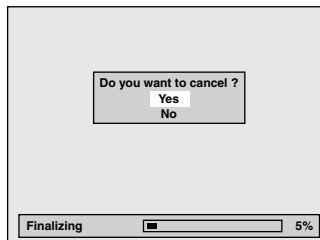

If "⊙" appears when **[STOP ■]** is pressed, you cannot cancel finalizing because the finalizing has already reached a critical point in its process.

If "No" is selected and **[ENTER]** or **[RETURN]** is pressed, finalizing is continued.

You cannot cancel finalizing a DVD-R, DVD+R and DVD+RW once it has started.

# INFORMATION ON DVD RECORDING

## Recording Mode

You can select a recording mode among 5 options, and the recording time will depend on the recording mode you select as follows.

Recording mode	Recording time		Video/ Sound Quality
	12cm	8cm	
XP	60 min	18 min	☆☆☆☆☆
SP	120 min	36 min	☆☆☆☆
LP	240 min	72 min	☆☆☆
EP	360 min	108 min	☆☆
SLP	480 min	144 min	☆

- The recording times listed above are estimates and are for reference purposes only. Actual recording times may vary.
- The audio and video quality of content being recorded may differ depending on the recording mode/recording time chosen.

### Note

- **This unit cannot record to CD-RW or CD-R.**
- DVD-RW/-R, DVD+RW/+R and CD-RW/-R recorded on a personal computer or a DVD or CD recorder may not be played back if the disc is damaged or dirty or if there is condensation on the player's lens.
- If you record a disc using a personal computer, even if it is recorded in a compatible format it may not be played back because of the settings of the application software used to create the disc. (Check with the software publisher for more detailed information.)
- Discs recorded in video mode on this unit cannot record additional information using other DVD recorders.
- Since the recording is made by the VBR (variable bit rate) method, depending on the picture you are recording, the actual remaining time for recording may be a little shorter than the remaining time displayed on the TV screen.

## Restrictions on Recording

You cannot record copy-protected program using this unit. Copy-protected video signal is included in DVD-videos, some satellite broadcasts, some pay-per-view stations and some "premium" stations.

If copy-protected material is detected, recording will pause or stop automatically and an error message appears on the screen.

"Copy-once only" video can only be recorded to CPRM compatible DVD-RW formatted in VR mode.

### What is "CPRM"?

CPRM is a copy protection system with scramble system regarding the recording of "copy-once" broadcast programs. CPRM stands for Content Protection for Recordable Media.

This unit is CPRM compatible, which means that you can record copy-once broadcast programs, but you cannot make another copy of those recordings. CPRM recordings can only be made on CPRM compatible DVD-RW formatted in VR mode, and CPRM recordings can only be played back on DVD players that are specifically compatible with CPRM.

### Making discs playable in other DVD players (Finalize)

For DVD-RW/-R, it is necessary to finalize the disc after recording, in order to play back the disc on other DVD players. (Refer to pages 31-33.) For DVD+RW/+R, it is recommended to finalize the disc in order to make the disc more compatible to other DVD player. When video and +VR mode disc are finalized, a title menu is created. You cannot finalize discs in other DVD recorders.

# SETTINGS FOR A RECORDING

## Make Recording Compatible



Use this feature to make the discs recorded on other unit recordable on this unit. When you make an additional recording on this unit with "Make Recording Compatible" set to "ON", the title list is automatically converted to our style.

- 1) Press [SETUP] and use [▲ / ▼] to select "General Setting", then press [ENTER].
- 2) Use [▲ / ▼] to select "Recording", then press [ENTER].  
"Recording" menu will appear.
- 3) Use [▲ / ▼] to select "Make Recording Compatible", then press [ENTER].
- 4) Use [▲ / ▼] to select "ON" or "OFF", then press [ENTER].

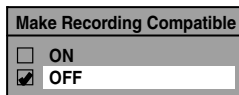

- ON:** Title list will be replaced when you make additional recordings to the discs recorded by other units.
- OFF:** Prohibiting additional record to the disc that has a title list created by other units.

- 5) Press [SETUP] to exit.

### Note

- This function is also available for unfinalized DVD+R.

## Setting for Auto Chapter



You can set a specified time for chapter marks.

- 1) Press [SETUP] and use [▲ / ▼] to select "General Setting", then press [ENTER].
- 2) Use [▲ / ▼] to select "Recording", then press [ENTER].  
"Recording" menu will appear.
- 3) Use [▲ / ▼] to select "Auto Chapter", then press [ENTER].
- 4) Use [▲ / ▼] to select a desired time option, then press [ENTER].

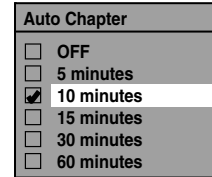

- 5) Press [SETUP] to exit.

### Note

- The interval for auto chapter may be up to two minutes different from the time option you set.
- A blank chapter may be created depending on the remaining time of the disc.

# SETTINGS FOR A RECORDING

## Recording Audio Select (XP)



You can enjoy high quality sound recording. This function works only when the recording mode is set at XP.

- 1) Press [SETUP] and use [▲ / ▼] to select "General Setting", then press [ENTER].
- 2) Use [▲ / ▼] to select "Recording", then press [ENTER].  
"Recording" menu will appear.
- 3) Use [▲ / ▼] to select "Recording Audio Select (XP)", then press [ENTER].
- 4) Use [▲ / ▼] to select "PCM" or "Dolby Digital", then press [ENTER].

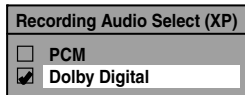

### PCM:

Records PCM audio for the best quality sound.

### Dolby Digital:

Records Dolby Digital audio for good quality sound.

- 5) Press [SETUP] to exit.

### Note

- "PCM" stands for Pulse Code Modulation. It changes analog sound to digital sound without compressing audio data.
- When the recording mode is set at other than XP, the unit records "Dolby Digital" audio automatically even if you selected "PCM".

## Setting Aspect Ratio for Video Mode Recording



You can set aspect ratio for video mode recording.

- 1) Follow step 1 to 2 on "Recording Audio Select(XP)".
- 2) Use [▲ / ▼] to select "Aspect Ratio (Video mode)", then press [ENTER].
- 3) Use [▲ / ▼] to select your desired setting, then press [ENTER].

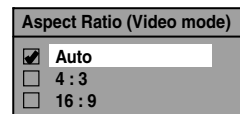

**Auto (default):** It will be recorded with whichever the ratio that the program you started to record are broadcasted with.

**4:3 :** Recorded in the aspect ratio of 4:3.

**16:9 :** Recorded in the aspect ratio of 16:9.

- 4) Press [SETUP] to exit.

### Note

- For DVD-RW VR mode, the image will be recorded in whichever the ratio that the program you record are broadcasted with, regardless of the "Aspect Ratio (Video mode)" setting.
- For DVD+RW/+R, the image will always be recorded in aspect ratio of 4:3.

# BASIC RECORDING & ONE-TOUCH TIMER RECORDING



Follow the steps to record TV programs.

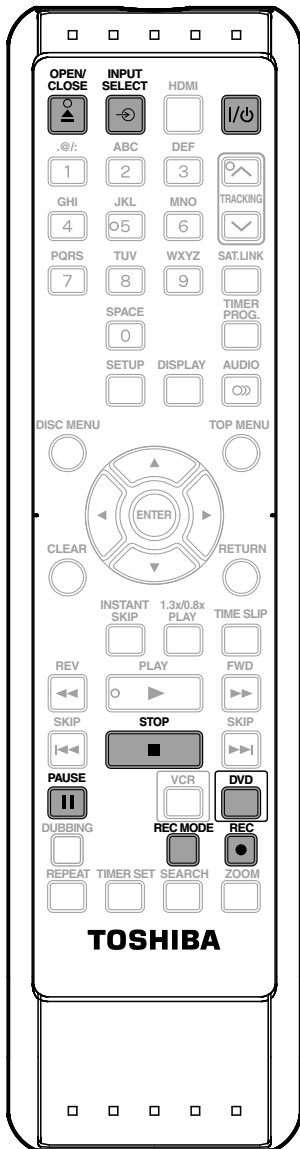

- 1 Press [I/O ON/STANDBY].**  
Turn on the TV and be sure to select the input to which the unit is connected.  
**Press [DVD].**

- 2 Press [OPEN/CLOSE ▲] to open the disc tray and insert your disc with its label facing up.**

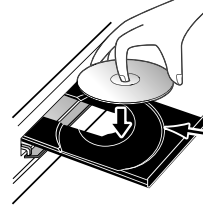

Align the disc to the disc tray guide.

- 3 Press [OPEN/CLOSE ▲] to close the disc tray.**

**It may take awhile to load the disc completely.**

- When inserting a brand-new DVD-RW or DVD+RW, the unit automatically starts to format.
- If titles have been recorded on the disc, the title list is displayed. Press [STOP ■] to exit the title list.

- 4 Press [REC MODE] repeatedly to select a recording mode.**  
Refer to "Recording Mode" on page 34 for DVD.

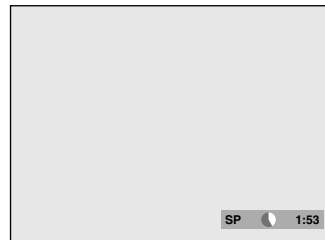

- 5 Press [INPUT SELECT ◉] to select the appropriate external input position (L1/L2) to which your external tuner is connected. Then select the desired channel to record on the external tuner.**

## 6 Press [REC ●] to start recording. "●" will be displayed for 5 seconds.

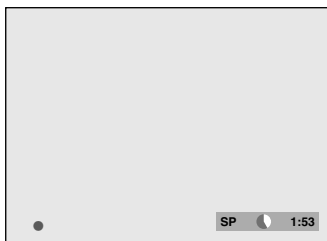

Press [PAUSE II] to pause recording.  
Press [PAUSE II] or [REC ●] again to restart recording.

### To set one-touch timer recording (OTR)...

This is a simple way to set the recording time in blocks of 30 minutes.

Press [REC ●] repeatedly until the desired recording time (30 minutes to 8 hours) appears on the TV screen.

One-touch timer recording will start.

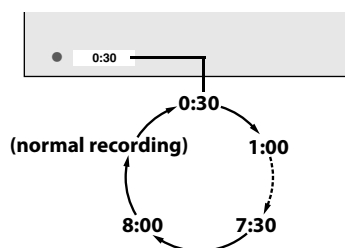

- To change the recording length during one-touch timer recording, press [REC ●] repeatedly until the desired length appears.
- To cancel one-touch timer recording within the specified time, press [STOP ■].

## 7 Press [STOP ■] to stop recording.

The recorded title will be included in the title list. (Refer to "Guide to a Title List" on page 71.)  
e.g.) DVD+R/DVD-RW/-R

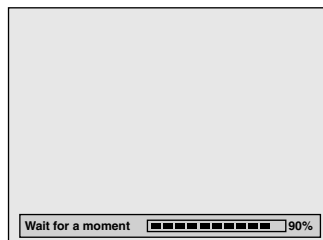

**This operation may take awhile to be completed.**

### Note

- When you press [REC ●], recording starts immediately and continues until the disc is full or you stop recording.
- When the unit clock has not been set, the space for a date and time of title names will be blank.
- You cannot change the recording mode during the recording pause mode.

### Note for one-touch timer recording

- The remaining recording time will be displayed on the front panel display during one-touch timer recording. Press [DISPLAY] to see it on the TV screen.
- Unlike the timer recording, you can perform the following operations during one-touch timer recording.
  - Turning the unit into the standby mode (One-touch timer recording will be canceled.).
  - Using [REC ●] or [STOP ■] on the remote control.
- You cannot use the pause function during one-touch timer recording.
- If DVD one-touch timer recording is completed during VCR playback or recording, the DVD will be in stop mode and the VCR keeps the current mode.
- When one-touch timer recording is finished and the power is turned into the standby mode, the unit will switch to the timer-standby mode automatically if a timer recording has been programmed. Press [TIMER SET] to cancel the timer-standby mode to use the unit continuously.

# TIMER RECORDING



You can program the unit to record up to 12 programs within a month in advance. Daily or weekly program recordings are also available.

## Before recording, make sure

- Connect the external tuner to either L1 or L2 and set it to output audio/video signals when it comes to the time you want to start recording.
- Do not change the external tuner's channel while you are recording. You cannot watch one channel and record another at the same time.
- Set the clock before setting a timer programming.
- Insert a recordable disc with enough recordable space or a cassette tape with an erase-protection tab.

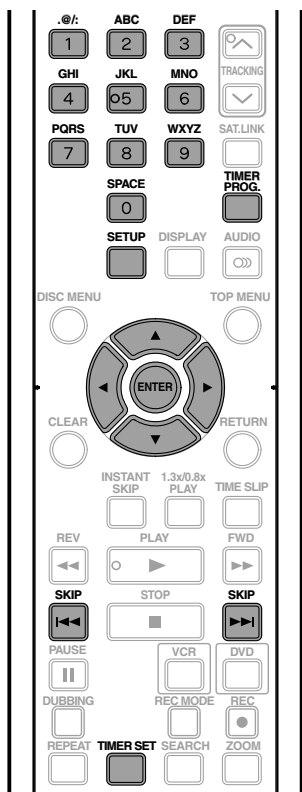

## Guide to Timer Programming Display

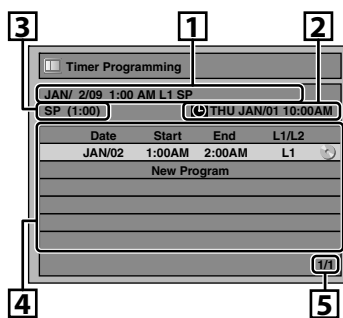

1. Title of a Timer Program (Contains date, time, external input, recording mode of the program)
2. Current date and time
3. Recording mode and length of the recording
4. Timer program list
5. Total number of pages and current page (2 pages maximum)

**1** Press [TIMER PROG.].

**2** Use [▲ / ▼] to select "New Program", then press [ENTER].

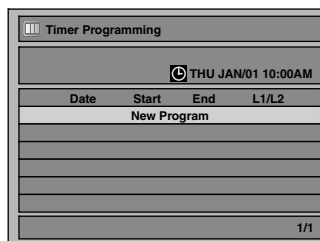

- If there are 6 or more programs, use [SKIP | ◀▶] to change pages.

## Note

### • If you have not set the clock yet:

- "Clock Setting" menu will appear instead of the timer programming list at step 1. Continue with the step 3 in "Clock Setting" on page 26 before setting a timer programming.
- Use [◀ / ▶] to move the cursor to the left and the right in "Timer Programming" menu.
- If a basic recording or one-touch timer recording is in progress on one component (e.g., VCR) and the timer recording set for the other component (e.g., DVD) is about to begin, the unit automatically switches to the programmed channel for timer recording 2 minutes before the programmed starting time, and the recording in progress (for VCR) will be canceled UNLESS their recording channels are the same. If their recording channels are the same, the timer recording will start without canceling the recording currently in progress. In this case, the recording of the same channel will be made on both DVD and VCR.
- You cannot make a program whose recording time exceeds 12 hours.
- Cancel the timer-standby mode by pressing [TIMER SET] before operation for either DVD or VCR. When finished operating, press [TIMER SET] to resume the timer-standby mode.
- In the timer-standby mode, you can turn on the power and use the component (VCR or DVD) which is not currently timer-programmed.

## 3 Use [▲ / ▼] to enter the date, then press [▶].

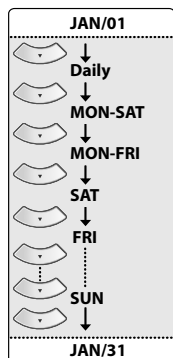

When pressing [▼] at the current date, the date will change as follows.

e.g.) January 1st

Refer to "Recording Mode" on page 34 for DVD or "Recording" on page 100 for VCR.

- You can check the remaining recordable space of the disc when you select the recording mode.

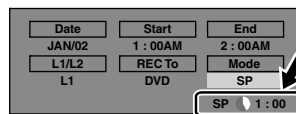

### Auto recording mode select (DVD only)...

When "Auto" is selected as a recording mode, the unit calculates how much time is available on the disc and determines the appropriate recording mode to complete recording the program.

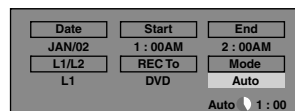

- "Auto" is only available for one program in the timer program list.
- The recording may be cut short, when the available recording space of the disc is too limited.

## 4 Use [▲ / ▼ / ◀ / ▶] or [the Number buttons] to enter the start and end time, then press [▶].

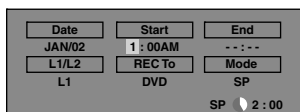

- You cannot make a program whose recording time exceeds 12 hours.

## 5 Use [▲ / ▼] to select an appropriate external input (L1/L2) to which your external tuner is connected, then press [▶].

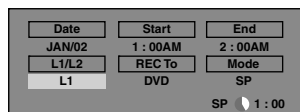

## 6 Use [▲ / ▼] to select a recording media ("DVD" or "VCR"), then press [▶].

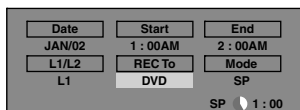

## 7 Use [▲ / ▼] to select a recording mode.

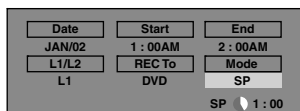

## 8 Press [ENTER] when all items are entered.

After displaying an instructive message for 10 seconds, timer program list will appear.

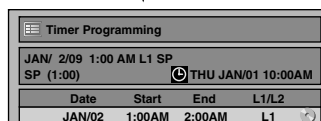
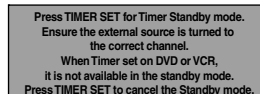

Your program setting is stored.

- To set another program, repeat steps 2 to 7.
- To exit, press [TIMER PROG.] or [SETUP].
- When 2 or more programs are overlapped, "Timer program overlapped" appears, and the overlapped program will be displayed in blue. To correct the timer program refer to "Checking, canceling, or correcting the timer programming information" on page 41.

## 9 Press [TIMER SET] to set a timer programming.

⌚ will appear on the front panel display, while this unit waits to make the recording.



"VCR" will appear on the front panel display if VCR timer recording have been set.



## To stop the timer recording in progress

- 1) Press [STOP ■] on the remote control.  
Confirmation message will appear.
  - 2) Select "Yes", then press [ENTER].
- To stop the timer recording immediately, press [STOP ■] on the unit.

## Checking, canceling, or correcting the timer programming information

- 1) Press [TIMER SET].
- 2) Press [TIMER PROG.].
- 3) Check the information on the list you want to edit.

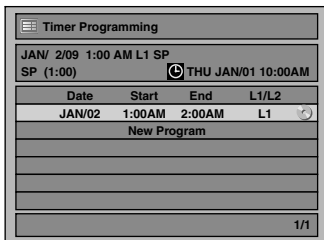

- 4-A) To delete the timer program:
  - 1 Use [▲ / ▼] to select the program you want to delete, then press [ENTER].
  - 2 Use [▲ / ▼] to select "Delete", then press [ENTER].  
Selection menu will appear.
  - 3 Use [▲ / ▼] to select "Yes", then press [ENTER].
- 4-B) To correct the timer program:
  - 1 Use [▲ / ▼] to select the program you want to correct, then press [ENTER].
  - 2 Use [▲ / ▼] to select "Program Change", then press [ENTER].
  - 3 Correct the timer program by using [▲ / ▼ / ◀ / ▶], then press [ENTER].
- 5) Press [TIMER PROG.] to exit.
- 6) Press [TIMER SET] to return to the timer standby mode.

### Note

- Press [TIMER PROG.] to check the timer recording in progress.  
When the timer recording is proceeding, that program will be highlighted in red. In this case, you cannot select any other program.

If the timer program did not complete correctly, the error number appears in the timer programming list.

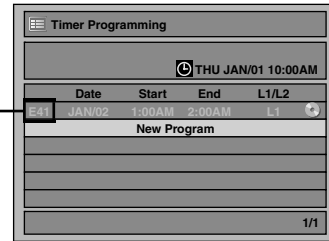

### Each error number means:





E1-22 E37-39	Recording error other than below	E40	Some portion has not been recorded because of program overlapping. Recording did not start at the start time.
E23-24	Unrecordable disc		
E25-28	Copy prohibited program		
E29	Disc protected	E41	Power failed
E30	Disc full	E42	No disc when recording
E31-32	Already 99 titles recorded	E43	Already 49 titles recorded
E33	Already 999 chapters recorded	E44	Already 254 chapters recorded
E34	No space for Control information	E45	Copy prohibited program
E35	PCA full *1	E46	It is impossible to record additionally on a disc recorded by other units when setting "Make Recording Compatible" to "OFF".
E36	Already finalized video format disc		

- A program with the error number is grayed in the timer programming list.
- Once the timer programming list with error line(s) is displayed, or after canceling and setting again the timer standby mode, the program line(s) with error will be cleared.

\*1 PCA is a disc's space reserved for recording test.

# TIMER RECORDING

## Hints for Timer Recording

- If there is a power failure or this unit has been unplugged for more than 30 seconds, the clock setting and all timer programming will be lost.
- If a disc is not inserted or if a inserted disc is not recordable (finalized DVD-RW/-R, finalized DVD+RW, a fully recorded disc, etc.), "DVD" on the front panel display flashes and timer recording cannot be performed. In some cases,  will appear momentarily around the start point as the unit attempts to record. Please insert a recordable disc.
- If a cassette tape with an erase-protection tab is not in the cassette compartment or there is no cassette tape in the cassette compartment, "VCR" on the front panel display flashes and timer recording cannot be performed. Please insert a recordable cassette tape.
- If you press **[TIMER SET]** and turn on the unit while either DVD or VCR is in timer standby mode,  disappears. In this case, you cannot change the mode between DVD and VCR. You cannot change any settings using **[SETUP]** or edit discs.
- When all the timer recording is completed,  flashes. To play back or eject the recorded disc, press **[I/O ON/STANDBY]** first, then select the recorded title and press **[PLAY ►]**, or **[OPEN/CLOSE ▲]** to remove the disc.
- During timer recording or timer standby mode ( will appear), any operations on the unit will not be available. To make these operations available, press **[STOP ■]** to stop the timer recording or **[TIMER SET]** to cancel timer standby mode ( will disappear).
- To cancel the timer standby mode, press **[TIMER SET]**.
- When the starting and the ending time are the same, "Exceeds 12 hours" appears and the program setting will not be accepted.
- When the programmed starting and ending time are earlier than the current time, the setting will not be accepted.
- If the starting time is earlier and the ending time is later than the current time, the recording will start right after **[TIMER SET]** is pressed.
- The timer recording cannot be performed in DVD and VCR at the same time. If you set 2 programming with the same channel and time in both devices, the program with a lower program number will be recorded.
- "Press TIMER SET for timer recording" will appear on the TV screen 5 minutes before the programmed starting time.

## The Priority of Overlapped Settings

This unit records the programs according to priority if the timer programmings are overlapped. The timer programming set previously has priority.

A timer recording of lower priority will be canceled or start from the middle.

Check the overlapped timer programmings and change the priority if necessary.

### ■ When the starting time is the same:

A program set previously (PROG. A) has priority.

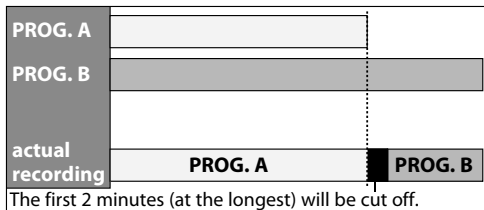

### ■ When the starting time and the ending time for each programs are different:

A program that has earlier start time has priority.

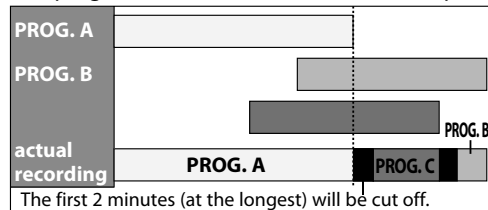

### ■ When the recording time is partially overlapped:

PROG. A will start after PROG. B is complete to be recorded.

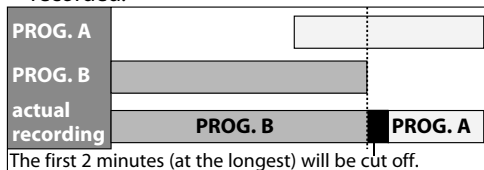

### ■ When the recording time is entirely overlapped:

PROG.A will not be recorded.

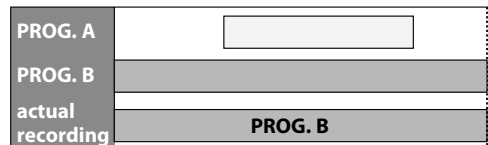

## Note for DVD recording

- When the recording time of 2 programs are overlapped, or the end time of a program and the start time of another program is the same, the first 2 minutes (at the longest) of the subsequent program will be cut off.
- If the cut-off portion comes up to 3 minutes or more, this program will be displayed with errors number E40 in the timer programming list.

### ■ When the end time of the programming currently being recorded and the start time of the subsequent program are same:

The beginning of the PROG. B may be cut off.

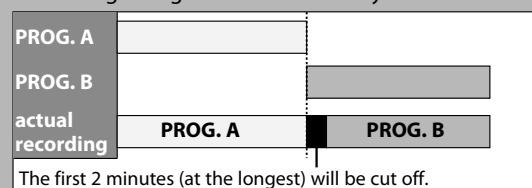

# SATELLITE LINK

You can set the unit to start recording whenever it detects the video signal from the external tuner.

## Preparing for the satellite link timer recording:

### Preparation on the tuner

- The external tuner should be equipped with some kind of timer function. Using timer function of the tuner, set it to output audio/video signals when it comes to the time you want to start recording, and stop output audio/video signals when it comes to the time you want to finish recording. Refer to the tuner's manual on how to set the timer.
- Make sure to set the satellite link standby mode when you finish setting.

### Preparation on this unit

- You must let the unit know which video input jack you are using before making a recording. Refer to "SETTINGS FOR THE VIDEO INPUT" on page 27.

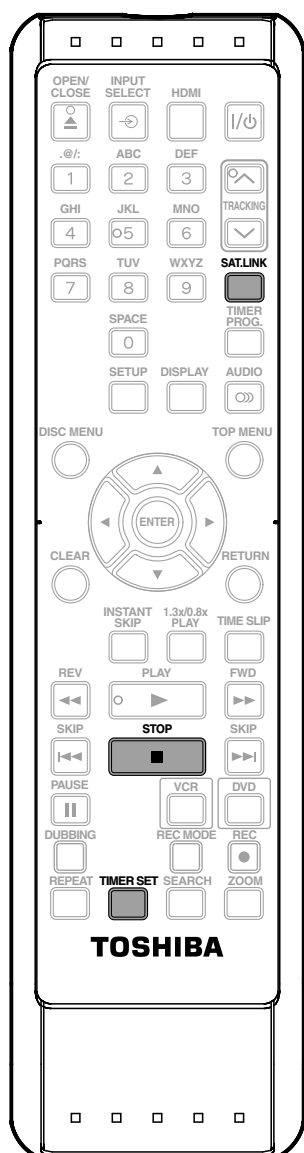

**1** Select whichever the component (DVD / VCR) you want to make a recording to. (Refer to page 14.)

**2** Select the desired recording mode. (Refer to "Recording Mode" on page 34 for DVD or "Recording" on page 100 for VCR.)

**3** Press [SAT. LINK].  
In a second, the unit will be turned into the standby mode automatically as it goes into the satellite link standby mode.

### To cancel the satellite link function while in the satellite link standby mode:

Press [SAT. LINK] or [TIMER SET].

### To cancel the satellite link function while the satellite link recording is in progress:

Press [STOP ■].

# SATELLITE LINK

## Note

- If the signal of external input breaks up over 5 seconds, satellite link function will be canceled.
- You cannot set the start or the end time for the satellite link timer recording on this unit.
- Recording picture will be distorted if the copy protection signal is being detected during satellite link timer recording.
- You can record the satellite link by using S-video input jacks on the rear panel. Refer to page 45 for more information.
- When a regular timer recording and the satellite link timer recording are overlapped, those recordings are recorded as illustrated below.

example 1	
timer recording	
satellite link	
actual recording	

The first 2 minutes (at the longest) will be cut off.

example 2	
timer recording	
satellite link	
actual recording	

example 3	
timer recording	
satellite link	
actual recording	

The first 2 minutes (at the longest) will be cut off.

# SETTINGS FOR AN EXTERNAL DEVICE

## Connection to an External Device

Connect the external device properly to the unit by using input jacks either L2 (Front) or L1 (Rear).

When connecting an external device of monaural output to this unit, use AUDIO L jack of L2 (Front).

Use S-video or the RCA audio/video cables for this connection.

When connecting a DVC (digital video camcorder), it is recommended to connect the DVC with the front DV IN jack with a commercially available mini DV/Firewire cable.

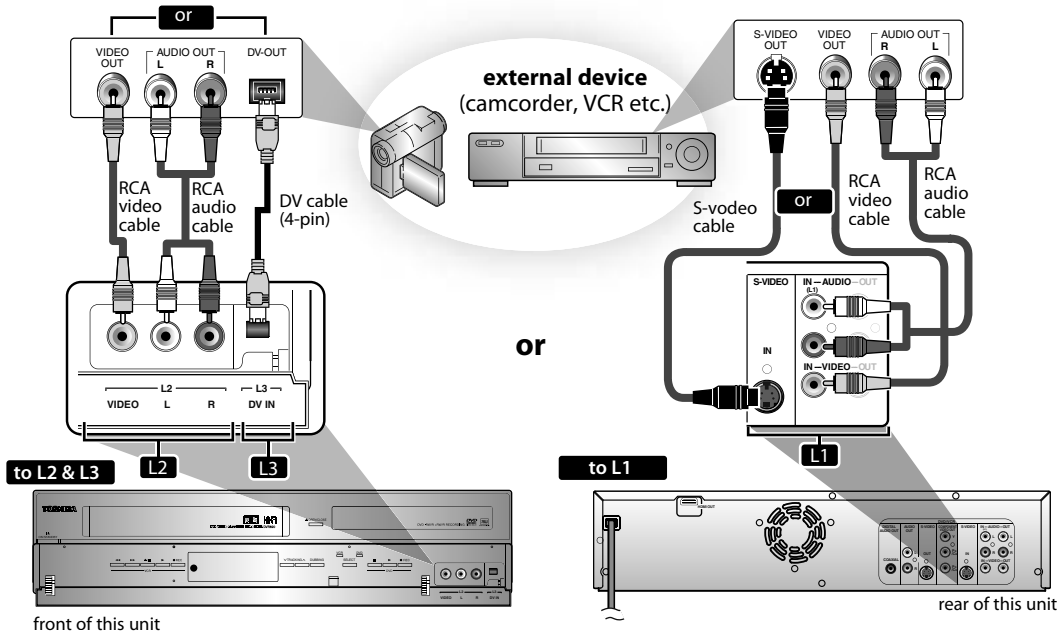

### Supplied cables used in this connection are as follows:

- RCA audio cable (L/R) x 1
- RCA video cable x 1

Please purchase the rest of the necessary cables at your local store.

# SETTINGS FOR AN EXTERNAL DEVICE

## Recording from an External Device



Before recording from an external device, refer to the instructions for the connection on page 45.

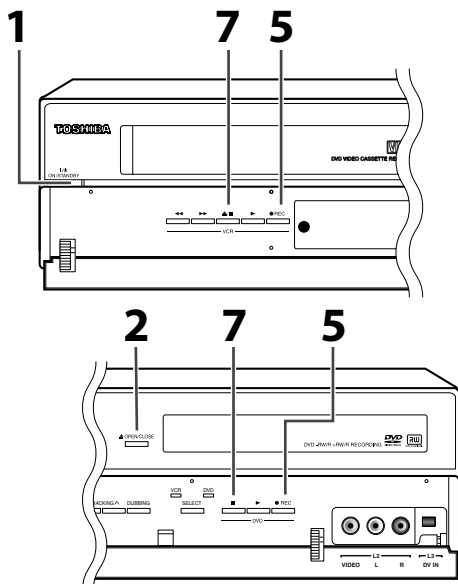
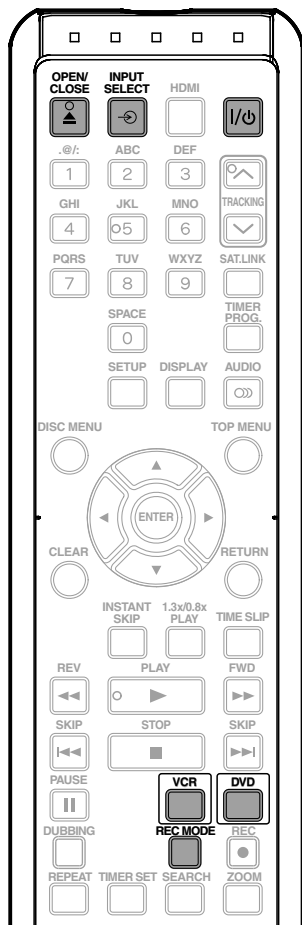

**1** Turn on the TV and press [I/O ON/STANDBY], and be sure to select the input of the TV to which the unit is connected.

**2** When you want to record to the disc:  
 Press [DVD].  
 Press [OPEN/CLOSE ▲] to open the disc tray. Place the disc to record properly. Press [OPEN/CLOSE ▲] again to close the disc tray.

It takes awhile to load the disc.

When you want to record to a cassette tape:

Press [VCR].  
 Insert the cassette tape with an erase-protection tab into the cassette compartment.

**3** Select the input of the unit which the external device is connected. (L1, L2 or DV(L3))

- To use the input jacks on the rear of this unit; Select "L1 (Rear)" by using [INPUT SELECT ◀].
- To use the input jacks on the front of this unit; Select "L2 (Front)" or "L3 (DV-IN)" by using [INPUT SELECT ◀].

**4** Press [REC MODE] repeatedly to select a recording mode.  
 Refer to "Recording Mode" on page 34 for DVD or "Recording" on page 100 for VCR.

**5** Press [● REC] on the unit to start recording.

**6** Start playback on the external device to record from.

**7** Press [STOP ■] / [EJECT/STOP ▲/■] on the unit to stop recording.

This operation may take awhile to be completed.

## Guide to DV and On-Screen Display

This function helps you to easily dub the contents of the DVC (digital video camcorder) to this unit. You can control basic operations of the DVC from the remote control of this unit such as playback, fast forward or reverse and stop all operations if the DVC is in video mode. Use the DV cable that has 4-pin input jack and is compliance with the IEEE1394 standards. When you connect to DV IN jack on the front of this unit, select "L3 (DV-IN)" position by using [INPUT SELECT -⊕] on the remote control and press [DISPLAY] to show the DV dubbing information for the operation of your DVC.

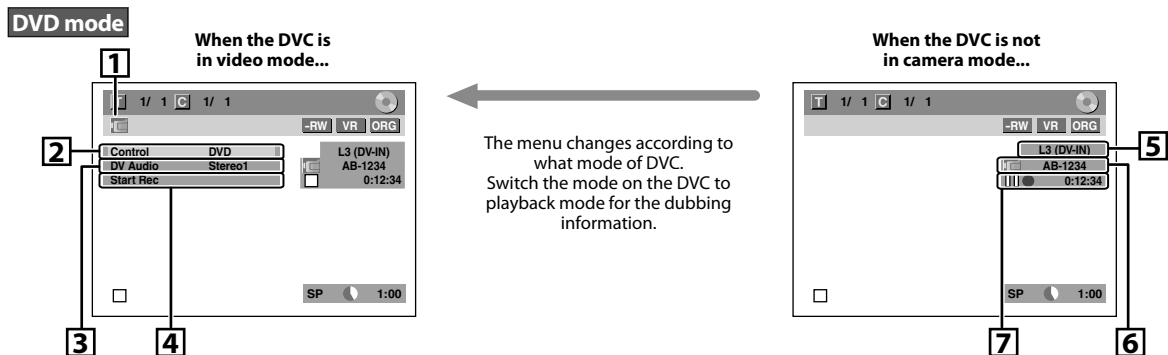

### VCR mode

You cannot control the DVC in VCR mode. For dubbing onto VCR, refer to page 49.

The following instructions are described with the operations using the remote control of this unit.

#### 1. DV icon

#### 2. Indicator of active device

- When the "Control" is highlighted, press [ENTER] to display the item selection. Use [▲ / ▼] to select the device you wish to operate, then press [ENTER] to activate.
- Select "DVD" to control this unit.
- Select "DVC" to control your DVC.

#### 3. Recording audio mode

- Other than the DVC is in stop mode, the "DV Audio" can be selected. Press [ENTER] to display the item selection and then use [▲ / ▼] to select the audio you wish to output. Press [ENTER] again to activate.
- Select "Stereo1" to dub the stereo sound.
- Select "Stereo2" to dub the sound with after recording sound.
- Select "Mix" to dub the stereo1 and stereo2.

#### 4. Indicator of dubbing function

- When the unit is ready for dubbing, "Start Rec" will appear.
- When the unit is in dubbing, "Pause Rec" will appear.

#### 5. Channel position

- When you select "L3 (DV-IN)" by using [INPUT SELECT -⊕], "L3 (DV-IN)" will appear.

#### 6. Product name of your DVC

- If the unit cannot recognize the input signal from the DVC or the unknown product, "No Device" or "\*\*\*\*\*" will appear instead.

#### 7. Status of the current operation and the time counter

Each icon means (Available icons may vary depending on the DVC):

- |                          |   |   |  |
|--------------------------|---|---|--|
| <input type="checkbox"/> | DVC is in stop mode.                        | ⏮ | DVC is fast reversing. (in stop mode)      |
| ▶                        | DVC is in playback mode.                    | ⏪ | DVC is fast reversing. (standard speed)    |
| ⏸                        | DVC is in pause mode.                       | ⏩ | DVC is fast reversing. (faster than above) |
| ▶▶                       | DVC is fast forwarding. (standard speed)    | ⏮ | DVC is fast reversing. (faster than above) |
| ▶▶▶                      | DVC is fast forwarding. (faster than above) | ⏮ | DVC is in slow reverse playback.           |
| ▶▶▶▶                     | DVC is fast forwarding. (faster than above) | ● | DVC is in recording.                       |
| ▶▶▶                      | DVC is slow forwarding. (standard speed)    | ⏸ | DVC is in recording pause mode.            |
| ▶▶▶▶                     | DVC is slow forwarding. (faster than above) |   |  |

## DVC to DVD Dubbing



Before recording from DVC, see page 45 for connection instructions.

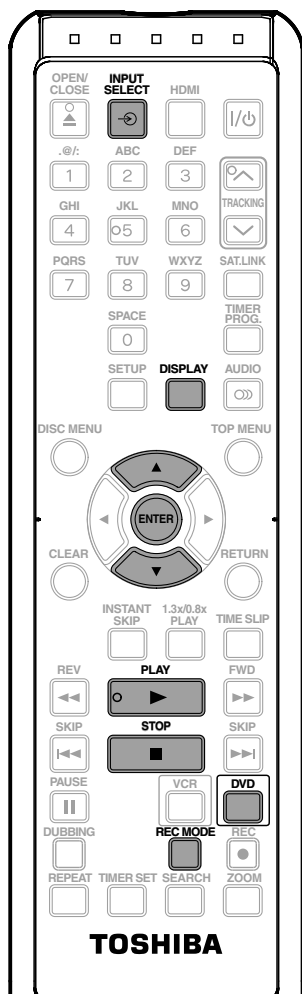

**TOSHIBA**

**Press [DVD] first.**

### Preparing for DV to DVD dubbing:

- Insert a recordable disc and make sure your DVC is in video mode.

# 1

Use [INPUT SELECT ] to select "L3 (DV-IN)".

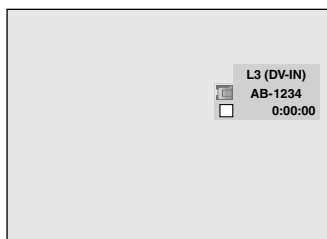

# 2

Press [REC MODE] repeatedly to select a recording mode.

(Refer to "Recording Mode" on page 34 for DVD or "Recording" on page 100 for VCR.)

# 3

Press [DISPLAY].

# 4

With "Control" highlighted, press [ENTER] to display the available devices to control with the remote control of this unit. Use [▲ / ▼] to select "DVC", then press [ENTER].

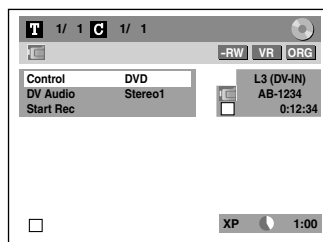

Now you can operate your DVC with the remote control of this unit.

# 5

Press [PLAY ▶] to start playing back the DVC, and find where you wish to start dubbing.

Then, press [STOP ■] when you come to the desired start point.

# 6

Use [▲ / ▼] to select "Start Rec", then press [ENTER].

The dubbing will start.

# 7

To stop dubbing;

Use [▲ / ▼] to select "Control", then press [ENTER].

Use [▲ / ▼] to select "DVD", then press [ENTER].

Then press [STOP ■].



## DVC to VCR Dubbing



Before recording from DVC, refer to page 45 for connection instructions.

**This DVC to VCR dubbing is available only for audio / video out connection and not available for S-video, component or HDMI connection. (Refer to "Information on VCR Functions" on page 100).**

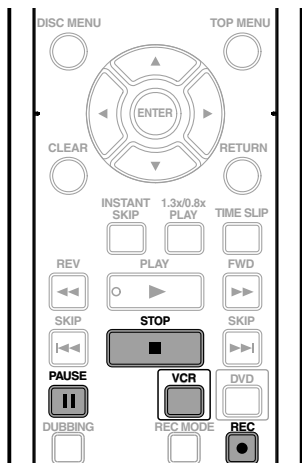

**Press [VCR] first.**

### Preparing for DV to VCR dubbing:

- Insert a recordable cassette tape and make sure your DVC is in video mode.

### Note for DV dubbing

- If you press [PAUSE II] at step 5 in "DVC to DVD Dubbing" on page 48, the tape will rewind to the point a few seconds preceding the paused point. When you press [ENTER] at step 6 in "DVC to DVD Dubbing" on page 48, then, it will start dubbing when it comes to the paused point.
- The unit does not send out the output signal to DVC.
- For the proper operation, connect DVC to the unit directly. Do not connect this unit and DVC via any other unit.
- Do not connect more than 1 DVC.
- The unit can only accept DVC. Other DV device such as cable/satellite box or D-VHS VCR cannot be recognized.
- If no video signal is detected from the DVC during DVC to DVD dubbing, the recording will be paused and "●" will flash on the TV screen. The recording will resume when the unit detects the video signal again.
- When the DVC is in camera mode, refer to "Guide to DV and On-Screen Display" on page 47.
- You cannot dub from DVC during timer standby mode.
- You cannot dub from DVC to the both DVD and VCR at the same time.
- You cannot change the output mode during DVC to VCR dubbing. If you want to switch to the DVD mode, stop the VCR first.
- During DVC to VCR dubbing, you cannot change channels while paused.
- When output is in DVD mode while playing back a DVD using L3(DV-IN), you cannot switch to the VCR mode.
- If you are using anything other than L3(DV-IN) to playback DVD, you can switch to the VCR mode, but cannot select L3(DV-IN) channel. (You can select L3(DV-IN) after switching to the DVD mode during VCR playback.)
- During timer standby of either component, you cannot select L3(DV-IN) even on the component which is not in timer standby.
- Date / time and cassette memory data will not be recorded.
- Pictures with a copy-guard signal cannot be recorded.
- A DV terminal is a terminal that can use the transmission mode conforming to the IEEE 1394 standards called "Fire Wire". It serves as the interface that connects the PC and peripheral device such as "i.LINK" (registered trademark of SONY). It enables digital dubbing between DV devices with little degradation.

**1 Repeat the steps 1 and 2 on page 48.**

**2 Press the PLAY button on your DVC to find where you wish to start dubbing. Then, press the PAUSE button on the DV camcorder when you come to the desired start point.**

**3 Press [REC ●] to start recording.**

**4 Press the PLAY button or the PAUSE button on your DVC to resume the playback.**

The dubbing will start.

**To pause the recording:**

Press [PAUSE II] once.

"●" will flash.

**To resume recording:**

Press [REC ●] or press [PAUSE II] again.

"●" will reappear.

**5 To stop recording, press [STOP ■].**

# DVD/VCR DUBBING



You can copy a DVD to a cassette tape or copy a cassette tape to a DVD. This function will be possible only if the DVD or the cassette tape is not copy protected.

Before starting this function, prepare for the recording on the DVD-RW/-R or the cassette tape. Refer to pages 34 and 100.

## Make sure:

- Insert a recordable disc and a cassette tape with an erase-protection tab.

## Note for recording to a cassette tape:

- The cassette tape's erase-protection tab is intact.
- The remaining time of the cassette tape is long enough.

## Note for recording to a disc:

- Make sure that the disc is recordable. Refer to page 9.

**1** Press [SETUP] and use [▲ / ▼] to select "General Setting", then press [ENTER].

"General Setting" menu will appear.

**2** Use [▲ / ▼] to select "Recording", then press [ENTER].

"Recording" menu will appear.

**3** Use [▲ / ▼] to select "Dubbing Mode", then press [ENTER].

Selection menu will appear.

Instructions continue on the next page.

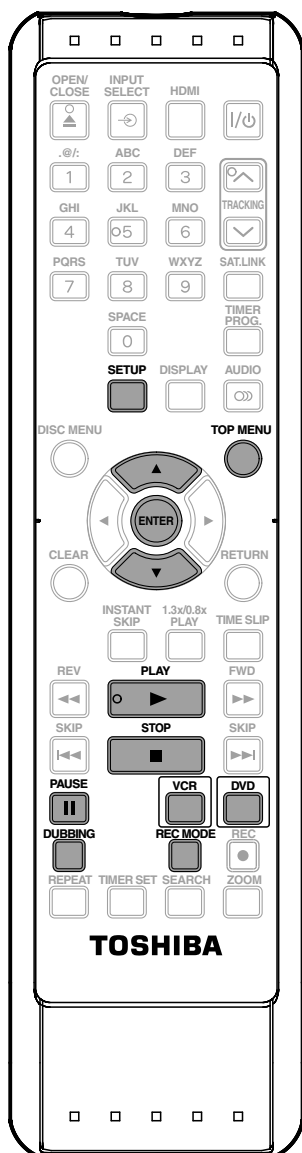

# DVD/VCR DUBBING

## VCR to DVD

**4** Use [**▲** / **▼**] to select “VCR → DVD”, then press [**ENTER**].

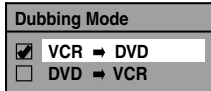

**5** Press [**SETUP**] to exit. Press [**VCR**].

**6** Press [**PLAY ▶**]. Then press [**PAUSE ||**] at the point you wish to start recording.

- Since it takes about a few seconds before the actual dubbing begins, please allow extra 5 seconds when selecting the starting point.

**7** Press [**DVD**], then press [**REC MODE**] repeatedly to select the desired recording mode.

**8** Press [**DUBBING**].  
VCR to DVD duplication will start.

**9** Press [**STOP ■**] to stop the recording.  
Title list will automatically appear.

- If you want to watch the duplicated material after the VCR to DVD duplication, press [**TOP MENU**] first then press [**ENTER**] twice.

## DVD to VCR

**4** Use [**▲** / **▼**] to select “DVD → VCR”, then press [**ENTER**].

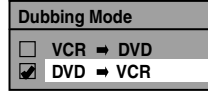

**5** Press [**SETUP**] to exit. Press [**DVD**].

**6** Press [**PLAY ▶**]. Then press [**PAUSE ||**] at the point you wish to start recording.

**7** Press [**VCR**], then press [**REC MODE**] repeatedly to select the desired recording mode.

**8** Press [**DUBBING**].  
DVD to VCR duplication will start.

**9** Press [**STOP ■**] to stop the recording.

### Note

- You cannot change the output mode during VCR to DVD or DVD to VCR duplication.
- When “L3 (DV-IN)” is selected as input, dubbing cannot be performed. Dubbing can be performed with either L1 or L2 inputs.

#### For CD to VCR duplication:

- This function is available on Audio CD, not MP3, WMA, JPEG nor DivX® files.

#### For DVD to VCR duplication:

- The recording mode for VCR cannot be displayed at step 7 when using HDMI / Component / S-Video connection. To display the VCR recording mode on the screen, the unit must be connected by the VIDEO OUT jack and the TV's input select should be set to the appropriate external input channel.

#### For VCR to DVD duplication:

- After starting VCR to DVD duplication, the picture may be distorted because of the auto tracking function. This is not a malfunction. Be advised to playback the cassette tape until the picture is stabilized, then set the starting point where you wish to start recording, and start VCR to DVD duplication.
- The playback sound mode is followed by the setting of VCR playback sound mode on page 102. Set the playback sound mode to which you wish to record to the DVD.
- This unit will automatically stop the duplication if playback with no image is for more than 3 minutes during VCR to DVD duplication.
- Dubbing indicator will appear on the front panel display during dubbing.

# INFORMATION ON PLAYBACK

## Structure of Disc Contents

The contents of DVD are generally divided into titles, and the titles are subdivided into chapters.

Audio CDs are divided into tracks.

Data disc contains MP3/WMA/JPEG/DivX® are divided into folders, and the folders are subdivided into files.

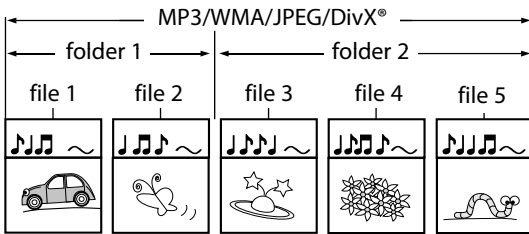
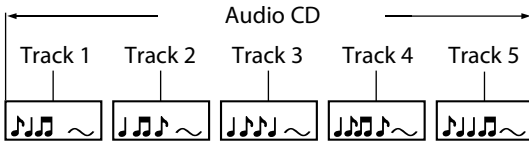
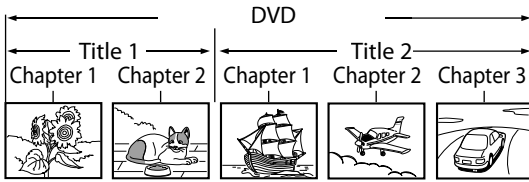

- Title: Divided contents of a DVD video. Roughly corresponds to a story title in short stories.
- Chapter: Divided contents of a title. This corresponds to a chapter in a story.
- Track: Divided contents of an audio CD.
- Folder: Divided contents of a MP3/WMA/JPEG/DivX® data disc. Consists of number of files.

Each title, chapter, or track, folder or file is assigned a number, which is called "title number", "chapter number", "track number", "folder number" or "file number" respectively.

Some discs may not have these numbers.

## Direct Playback

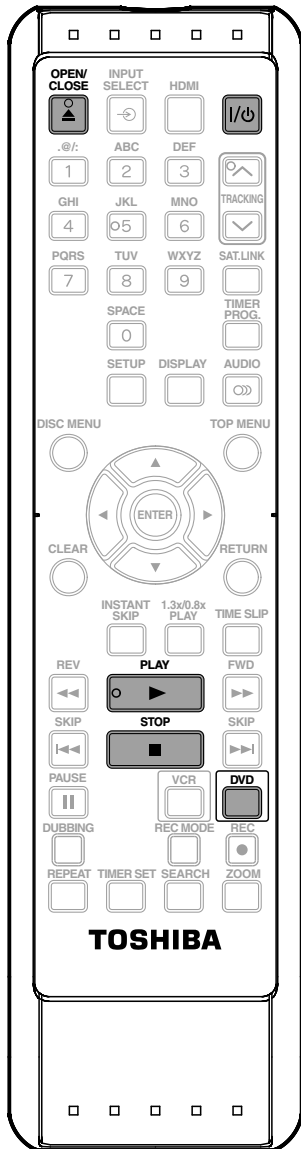

**1** Press [I/O ON/STANDBY].  
Turn on the TV and be sure to select the input to which the unit is connected.

Press [DVD].

**2** Press [OPEN/CLOSE ▲] to open the disc tray and insert your disc with its label facing up.

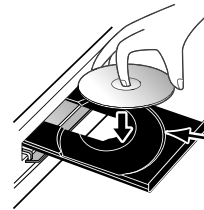

Align the disc to the disc tray guide.

**3** Press [OPEN/CLOSE ▲] to close the disc tray.

It may take awhile to load the disc completely.

**4** Press [PLAY ►] to start playback.

If you are playing back a DVD-video, a menu may appear.  
Refer to "Using the Title/Disc Menu" on page 58.

**5** Press [STOP ■] once to stop playback temporarily.

• Refer to "Resume Playback" on page 59.

### Note

- Some discs may start playback automatically.
- Playback will stop when you change the output mode.

## Playback from the Title List

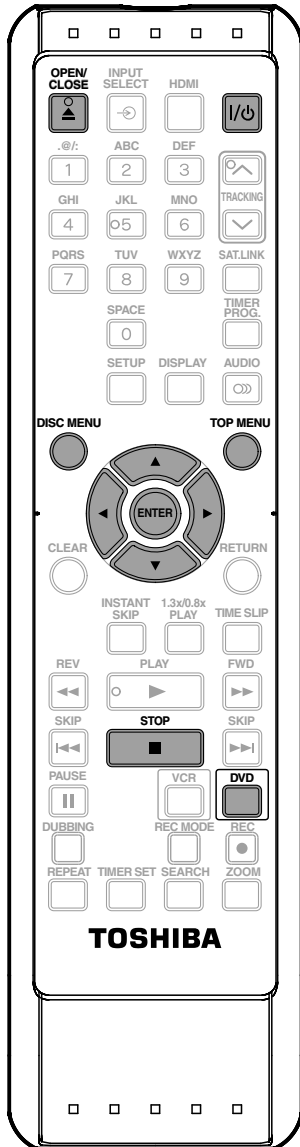

- 1 Press [I/⏻ ON/STANDBY].**  
Turn on the TV and be sure to select the input to which the unit is connected.  
**Press [DVD].**

### Note

- You can also start playback by pressing [PLAY ▶] instead of [ENTER].
- At step 4, you can press [SKIP ▶▶], or press [▶] when the title on the lower right of the title list is highlighted to display the next page, and press [SKIP ◀◀], or press [◀] when the title on the upper left of the title list is highlighted to display the previous page.

- 2 Press [OPEN/CLOSE ▲] to open the disc tray and insert your disc with its label facing up.**

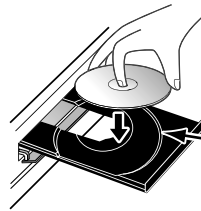

Align the disc to the disc tray guide.

- 3 Press [OPEN/CLOSE ▲] to close the disc tray.**

It may take awhile to load the disc completely.

- 4 Press [TOP MENU].**  
Title list will appear.  
Press [DISC MENU] to switch Original/Playlist if necessary.

  - To exit the title list, press [STOP ■].
  - To resume the title list, press [TOP MENU].

- 5 Use [▲ / ▼ / ◀ / ▶] to select a desired title, then press [ENTER].**  
e.g.) VR mode DVD-RW original

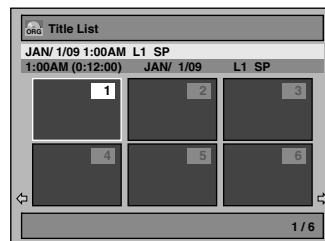

- 6 Use [▲ / ▼] to select "Play From Start", then press [ENTER].**



Playback will start.

- 7 Press [STOP ■] once to stop playback temporarily.**

- Refer to "Resume Playback" on page 59.

To eject the disc, press [OPEN/CLOSE ▲] to open the disc tray, then remove the disc before turning off the unit.

## Playing Back an Audio CD and a CD-RW/-R with MP3/WMA/JPEG Files

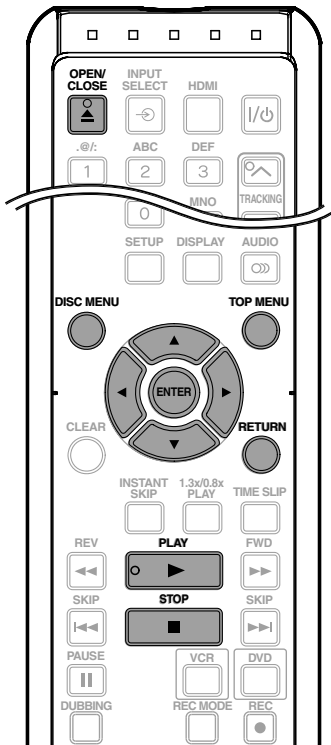

**1** Follow steps 1 to 2 in “Direct Playback” on page 53.

**2** Press [OPEN/CLOSE ▲] to close the disc tray.  
It may take awhile to load the disc completely.

When an audio CD is inserted, track list will appear.

When you insert a CD-RW/-R mixed with MP3/WMA/JPEG files, the playback media selection screen will be displayed.

For MP3/WMA, select “Music”, for JPEG, select “Photo”. When a CD-RW/-R with MP3/WMA/JPEG files is inserted, file list will appear.

- To exit the file list, press [STOP ■].
- To resume the file list, press [TOP MENU].
- Press [DISC MENU] to call up the playback media selection screen in stop mode.

**3** Use [▲ / ▼] to select a desired folder or track/file, then press [ENTER].  
e.g.) JPEG file list

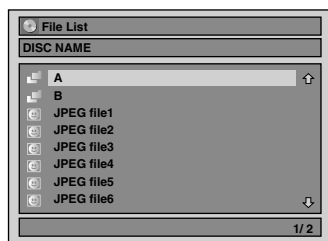

### When selecting track/file:

Playback will start.





### When selecting folder:

The files in the folder will appear.

Use [▲ / ▼] to select the file or folder you want to play back, then press [ENTER].

- Press [PLAY ▶], [ENTER] or [▶] to move to any lower hierarchies.
- Press [◀] or [RETURN] to move back to the previous hierarchy.

### Hints for audio CD tracks and MP3 / WMA / JPEG files:

- Folders are shown by .
- Audio CD tracks are shown by .
- MP3 files are shown by .
- WMA files are shown by .
- JPEG files are shown by .
- The system can recognize up to 255 folders and, up to 99 tracks/999 files.
- Letters of a file/folder name overflowing the given space will be displayed as “...”.
- If there are no files in the folder, “No Files” will be displayed.

### It is recommended that files to be played back in this unit are recorded under the following specifications:

#### <MP3 / WMA>

- Sampling frequency : 44.1 kHz or 48 kHz.
- Constant bit rate : 112 kbps - 320 kbps (MP3), 48 kbps - 192 kbps (WMA).

#### <JPEG>

- Upper limit : 6,300 x 5,100 dots.
- Lower limit : 32 x 32 dots.
- File size of image maximum : 12 MB.

### Note

- The audio source of MP3 files cannot be recorded as digital sound by an MD or DAT deck.
- Files whose extension is other than “.mp3(MP3)” “.wma(WMA)” or “.jpg / .jpeg(JPEG)” will not be listed.
- Some unplayable folders or files may be listed due to the recording status.
- High-resolution JPEG files take longer to be displayed.
- Progressive JPEG files (JPEG files saved in progressive format) cannot be played back on this unit.
- The JPEG pictures can also rotate by using [◀ / ▶].

This DVD Video Recorder requires discs/recordings to meet certain technical standards in order to achieve optimal playback quality. There are many different types of recordable disc formats (including CD-R containing MP3/WMA files). Not all recordable discs will operate or produce optimal playback quality. The technical criteria set forth in this owner's manual are meant only as a guide. Use of CD-RW for MP3 files is not recommended.

You must obtain any required permission from copyright owners to download or use copyrighted content. Toshiba cannot and does not grant such permission.

## Playing Back a DivX®

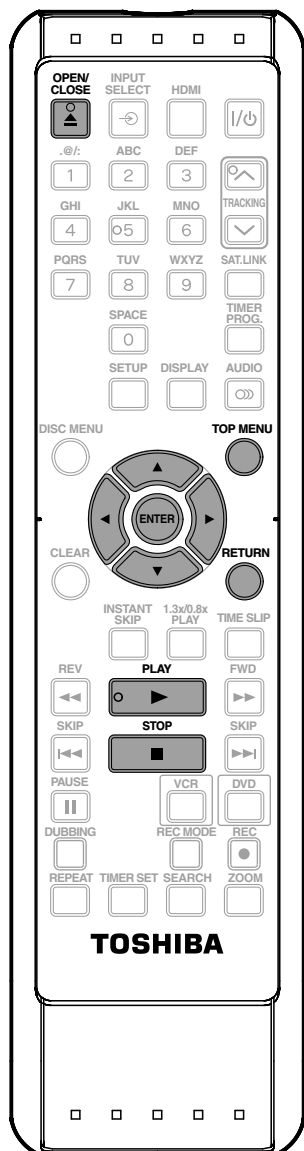

**1** Follow steps 1 to 2 in “Direct Playback” on page 53.

**2** Press [OPEN/CLOSE ▲] to close the disc tray.

**It may take awhile to load the disc completely.**

File list will appear automatically.

- To exit the file list, press [STOP ■].
- To resume the file list, press [TOP MENU].

**3** Use [▲ / ▼] to select the desired folder or file, then press [ENTER].

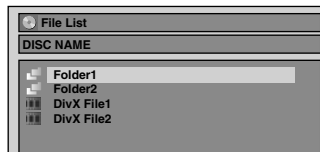

**When selecting file:**

Playback will start.

**When selecting folder:**

The files in the folder will appear.

Use [▲ / ▼] to select the file you want to play back, then press [ENTER].

- Press [PLAY ►], [ENTER] or [►] to move to any lower hierarchy.
- Press [◀] or [RETURN] to move back to the previous hierarchy.

### DivX® subtitle

The subtitle created by the user can be displayed during DivX® playback.

**1) After selecting the DivX® file, the “Subtitle List” menu will appear when “DivX Subtitle” is set to anything other than “OFF”. (Refer to page 96.)**

**2) Use [▲ / ▼] to select the extension you want to display, then press [ENTER].**

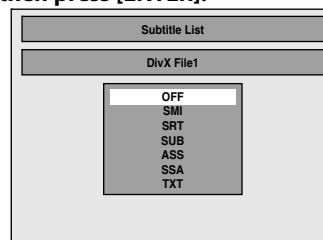

DivX® with the subtitle starts playback. The subtitle cannot be displayed when the setting is “OFF”.

- If there is more than one extension, the extension selection appears in the subtitle list.



# BASIC PLAYBACK

**It is recommended that files to be played back in this unit are recorded under the following specifications:**

Official DivX® Certified product

- Playable codec of AVI files : DivX®3.x, DivX®4.x, DivX®5.x, DivX®6.0
- Maximum size of image : 720 x 480 @30 fps  
720 x 576 @25 fps
- Sampling frequency of audio: 8 kHz - 48 kHz
- Audio type : MPEG1 audio layer 3(MP3), MPEG1 audio layer 2, Dolby Digital

**Hint for the purchased or rental official DivX® Certified product**

- When you purchased or rental a DivX® file through the official site of DivX® video which is called DivX® Video-On-Demand (VOD) services, a registration code is required every time you get the new file from the DivX® VOD services. Refer to "DivX® VOD" on page 96.

- Some DivX® VOD files are restricted with the limited playable times (you cannot play them back beyond the limit). If your DivX® VOD file has such limit, the playback confirmation screen will appear.

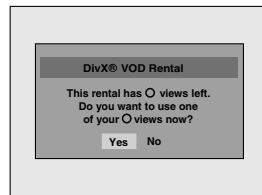

Use [◀/▶] to select "Yes" if you want to play back the file, or to select "No" if you do not wish to play it back.

Then, press [ENTER] to confirm the selection.

- You cannot play back the DivX® VOD files, of which rental period has been expired. In such case, press [TOP MENU] and select other files that can be played back.

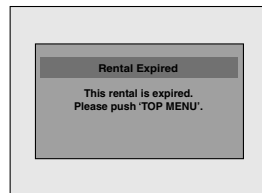

## Note for DivX®

- DivX® is a codec (compression/decompression) that can compress images to a very small amount of data. The software can compress video data from almost any devices to the size that can be sent on the Internet without compromising visual quality of the images.
- A file with an extension of ".avi" and ".divx" is called an DivX® file. All files with the ".avi" extension are recognized as MPEG4.
- Files whose extension other than ".avi" and ".divx" will not be listed on the DivX® menu. However, unplayable folders and files may be displayed, depending on the recording conditions.
- Even if the file has an extension of either ".avi" and ".divx", this unit cannot play it back if it is recorded in the format other than DivX®.
- A symbol of  is shown on the top of the file name.
- A maximum of 255 folders or 999 files may be recognized in a disc.
- Up to 8 hierarchies can be recognized in a folder. Files in the 9th or deeper hierarchies cannot be played back.
- If there are more than 9 files, a down arrow "↓" appears, indicating that the user can view another part on the previous page. The current page number and the number of total pages are shown on the bottom of the screen.
- Letters of a file/folder name overflowing the given space will be displayed as "...".
- You can play back the disc recorded in multi-session.
- It may take awhile for audio and images to be output after you inserted a disc and pressed [PLAY ▶].
- When playing back the files recorded in high bit rates, the images can be interrupted in some occasions.
- Although DivX® logo has been obtained for this unit, it may not be able to play back some data, depending on the characteristics, bit rates, or audio format settings, etc.
- A DivX® file whose file size exceeds 2 GB cannot be played back.
- If a large-sized DivX® file is selected, it may take awhile to start the playback (over 20 seconds sometimes).
- If you try to playback the DivX® file that has the screen resolution which this unit does not support, the playback will be stopped and error message will appear.

- If DivX® files written on a CD-RW/-R cannot be played back, rewrite them on a DVD-RW/-R or DVD+RW/+R and try to play back.

- For more information for DivX®, please visit <http://www.divx.com>.

- If you insert a CD-RW/-R with DivX® files that are mixed with MP3/WMA/JPEG files, the playback media selection screen will be displayed.

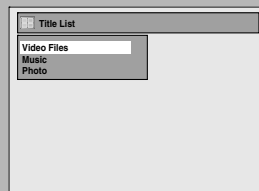

Please select "Video Files" and proceed to next step.

- Press [DISC MENU] to call up the Title List in stop mode.
- If you select "Music" instead of "Video Files" on Title List, this unit can play back MP3/WMA files.
- If you select "Photo" instead of "Video Files" on Title List, this unit can play back JPEG files.
- Some DivX® files cannot be played back on this unit due to the configuration and characteristics of the disc, or due to the condition of recording and authoring software.
- You cannot play back the DivX® VOD files obtained with different registration codes on this unit. Press [TOP MENU] and select other files that can be played back.



## Note for DivX® subtitle

- To utilize this function, the following conditions must meet.
  - "DivX Subtitle" must be activated in "DivX" menu. (Refer to "DivX Subtitle" on page 96.)
  - Playback file and the subtitle file must have the same name.
  - Playback file and the subtitle file must locate in the same folder.
  - Only the subtitle files with the following extensions are supported; .smi (.SMI), .srt (.SRT), .sub (.SUB), .ass (.ASS), .ssa (.SSA), .txt (.TXT). (.sub (.SUB) and .txt (.TXT) files may not be recognized.)
  - The subtitles that exceeds the playback time of the DivX® file will not be displayed.

# BASIC PLAYBACK

## Using the Title/Disc Menu



DVD may contain a title list, which describes the contents of the disc, or a disc menu, which guides you through the available functions in the disc.

**Press [DVD] first.**

- 1) Press [TOP MENU] or [DISC MENU] to call up the title list or disc menu.
- 2) Use [▲ / ▼ / ◀ / ▶] to make a selection, and then press [ENTER] to enable your selection.
- 3) Press [STOP ■] to exit the disc menu.

### Note

- You can select a numbered menu with [the Number buttons] also.
- Menus vary among discs. Refer to the information accompanying the disc for details.
- [DISC MENU] or [TOP MENU] will not always be effective for all DVDs.

## Pause

**Press [DVD] first.**

- 1) During playback, press [PAUSE II].

Playback will be paused and sound will be muted.



- 2) Press [PLAY ►] to return to the normal playback.

### Note

- For DVD / DivX® files, set "Still Mode" to "Field" in "Playback" menu if pictures in the pause mode are blurred. (Refer to page 91.)

## Resume Playback

You can play back from where you stopped playing back the disc last.

**Press [DVD] first.**

**1) During playback, press [STOP ■].**

The resume message will appear.

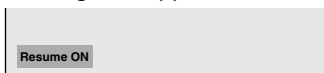

**2) Press [PLAY ►].**

In a few seconds, playback will resume from the point at which it stopped last. You can resume playback at the same point even if you turn the unit into the standby mode.

To cancel the resume playback and start playing back the disc from the beginning, press [STOP ■] again while the playback is stopped.

### Note

- For MP3/WMA/JPEG files, playback will resume from the beginning of the file at which playback was stopped.

## Fast Forward / Fast Reverse Playback



**Press [DVD] first.**

**1) During playback, press [FWD ►►] or [REV ◄◄].**

Every time you press [FWD ►►] or [REV ◄◄], approximate speed will be changed as follows.

Fast forward or fast reverse playback across titles (for DVD), or files (for MP3 / WMA / DivX® files) is not possible.

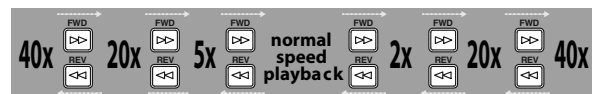

For audio CD or MP3/WMA files, approximate speed is fixed at 8x with sound.

Picture quality of DivX® files in fast reverse is lower than that in fast forward.

For some DivX® files, fast forward/fast reverse may not function.

**2) Press [PLAY ►] to return to the normal playback.**

### Note

- Forward/reverse speed will be indicated with icons as follows.

forward (approx. speed)

2x: ►►

20x: ►►►

40x: ►►►►

reverse (approx. speed)

5x: ◄◄

20x: ◄◄◄

40x: ◄◄◄◄

## Skipping TV Commercials During Playback



You can skip TV commercials to enjoy the recorded programs without interrupting.

**Press [DVD] first.**

**During playback, press [INSTANT SKIP].**

Normal playback will start at 30 seconds ahead from where you press [INSTANT SKIP].

Every time you press [INSTANT SKIP], the searching point will be extended by 30 seconds ahead.

You can press [INSTANT SKIP] up to 6 times (180 seconds).

e.g.) Press [INSTANT SKIP] once.

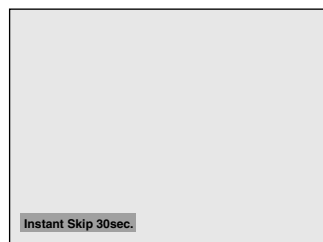

(forwarding 30 seconds)

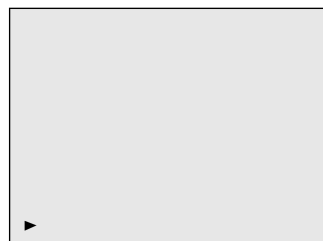

Playback will return to the normal playback.

# SPECIAL PLAYBACK

## Rapid Playback



Rapid playback function is available only during playback.

This function is available only on discs recorded in the Dolby Digital format, and plays back in a slightly faster/slower speed while keeping the sound output.

Press [DVD] first.

1) During playback, press [1.3X / 0.8X PLAY].

- ▶ x0.8 : Press [1.3X / 0.8X PLAY] once during playback. Plays back approximately at 0.8 times of normal playback.
- ▶ x1.3: Press [1.3X / 0.8X PLAY] twice during playback. Plays back approximately at 1.3 times of normal playback.
- ▶ : Press [1.3X / 0.8X PLAY] thrice to play back in normal speed. No effects.

2) Press [PLAY ►] to return to the normal playback.

### Note

- Audio (language) setting cannot be changed while using this mode.
- This feature may not work at some point in a disc.
- Audio is LPCM (2 channel) during rapid playback.

## Step by Step Playback



Press [DVD] first.

1) During playback, press [PAUSE II].

Playback will be paused and sound will be muted.

2) Press [SKIP ►►I] repeatedly.

Playback will advance one frame at a time when you press [SKIP ►►I] with the sound muted.

To play back step by step backward:

Press [SKIP I◀◀] repeatedly.

Every time you press the button, the playback will go backward by one frame.

- Press and hold [SKIP I◀◀] / [SKIP ►►I] to reverse/advance continuously.

3) Press [PLAY ►] to return to the normal playback.

### Note

- Only step by step forward playback is available for playing back DivX® files.

## Slow Forward / Slow Reverse Playback



Press [DVD] first.

1) During playback, press [PAUSE II]. Then press [FWD ►►] or [REV ◀◀].

Every time you press [FWD ►►] or [REV ◀◀], approximate speed will be changed as follows. (The sound will remain muted.)

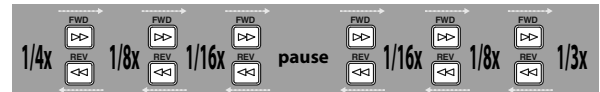

2) Press [PLAY ►] to return to the normal playback.

### Note

- Forward/reverse speed will be indicated with icons as follows.
  - forward (approx. speed)
  - 1/16x: ►►►
  - 1/8x: ►►►►
  - 1/3x: ►►►►►
  - reverse (approx. speed)
  - 1/16x: ◀◀◀
  - 1/8x: ◀◀◀◀
  - 1/4x: ◀◀◀◀◀
- For some DivX® files, slow forward/slow reverse may not function.
- Only slow forward is available when playing back DivX® files.

## Zoom



Press [DVD] first.

1) During playback, press [DISPLAY] or [ZOOM].

- If you press [ZOOM], skip to step 3.

2) Use [◀/▶] to select to display the selection menu.

e.g.) DVD-video

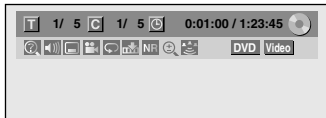

3) Use [▲/▼] to select a desired zoom factor to zoom, then press [ENTER].

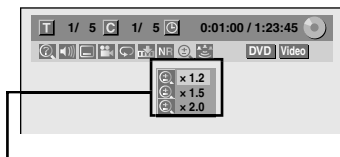

Zoom menu will appear.

There are four options

(x1.0, x1.2, x1.5 and x2.0), these are displayed excluding the current zoom rate.

Zoom area will be displayed.

4) Use [▲/▼/◀/▶] to select a desired zoom position, then press [ENTER].

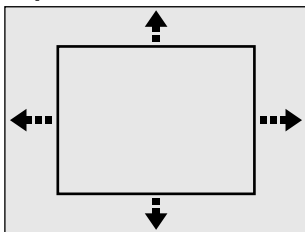

Zoom playback will start.

### Note

- When selecting a smaller factor than the current one, the zoom area will not be displayed.
- To exit the zoom menu, press [RETURN] repeatedly.
- To cancel the zoom function, select "x1.0" using [▲/▼], then press [ENTER] at step 3.
- You cannot slide the zoomed picture on some JPEG files.

## Marker Setting



This feature allows you to assign a specific point on a disc to be called back later.

Press [DVD] first.

1) During playback, press [DISPLAY] to bring up the display menu.

If the display menu is already shown, skip to step 2.

2) Use [◀/▶] to select to display the marker list.

e.g.) DVD-video

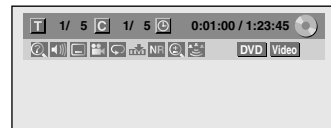

3) Use [▲/▼] to select a desired marker number.

When it reaches the desired point, press [ENTER].

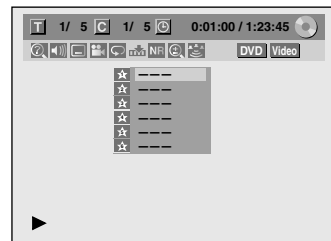

The title (track) number and the time will be displayed.

4) To return to the marker:

Use [▲/▼] to select the desired marker number, then press [ENTER].

### Note

- To clear a marker, select the marker number to be cleared, then press [CLEAR].
- All markers will be erased when you operate these operations listed below.
  - Opening the disc tray
  - Turning the unit into the standby mode.
  - Recording on a recordable disc
- You can mark up to 6 points.

## Chasing Playback during Recording



You can play back the already recorded part of the currently recording program without waiting for the recording to the end. **This function works from 1 minute after the start of the recording.**

### 1) During recording, press [PLAY ►].

Playback will start from the beginning of the program that you are currently recording.

Screen for the current playback:



If you play back the fast forward playback and the playback reaches the scene recorded 1 minute before, the forwarding playback will automatically return to the normal playback.

### 2) Press [STOP ■] once to stop playback.

The resume message will appear.

Screen for the current recording:

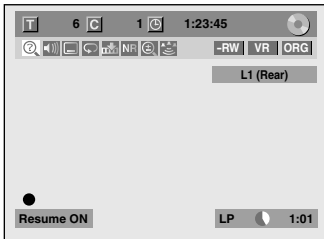

To stop recording, press [STOP ■] again.

To cancel the resume, press [STOP ■] again.

### Using [TIME SLIP] ...

With [TIME SLIP], even if you leave your couch while you are watching TV through this unit, you can come back and watch rest of the program from right where you left at any convenient time with just one button. Please make sure to put VR mode DVD-RW disc, and set the recording mode to LP, EP or SLP.

#### 1) While viewing a TV broadcast via this unit, press [TIME SLIP].

This unit start to record the TV broadcast.

#### 2) Press [TIME SLIP] again.

Playback will start from the point at which you press [TIME SLIP] first while recording continues.

- While viewing the recorded content, you can pause and resume the playback by pressing [TIME SLIP].

#### 3) Press [STOP ■] once to stop playback.

To stop recording, press [STOP ■] again.

To cancel the resume, press [STOP ■] again.

### Note

- Playback image may freeze momentarily using this function. However, this does not affect the recording.
- The 2x fast forward playback is not available.
- [REC ●] is not available during this function.
- You must cancel this function first by pressing [STOP ■] once. Then you can use [REC ●] to use OTR (one-touch timer recording) function or change recording time for the OTR.
- "Wait for a moment." will be displayed on the screen if you press [PLAY ►] before 1 minute of recording.
- **This function is available only when you are recording on a DVD-RW in VR mode, with the recording mode LP, EP or SLP.**

## Simultaneous Playback and Recording



You can also play back a recorded title during current recording or the timer recording on the same disc.

### 1) During recording, press [DISPLAY].

Screen for the current recording:

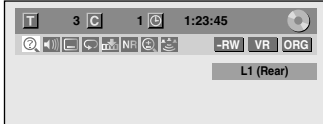

### 2) Select icon using [◀/▶], then press [ENTER].

The title number next to **T** will be highlighted.

#### Title:

Enter a desired title number to search using [▲ / ▼] or [the Number buttons], then press [ENTER].

Selected title playback will start.

#### Chapter:

To move to **C** for chapter, press [▶].

Enter a desired chapter number to search using [▲ / ▼] or [the Number buttons], then press [ENTER].

Selected chapter playback will start.

If you play back the currently recording program and the playback reaches the scene recorded 1 minute before, the forwarding playback will automatically return to the normal playback.

### 3) Press [STOP ■] once to stop playback.

The resume message will appear.

Screen for the current recording:

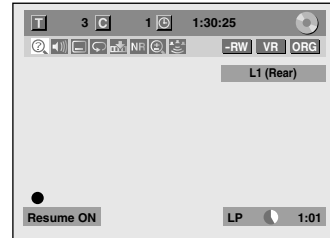

To stop recording, press [STOP ■] again.

To cancel the resume, press [STOP ■] again.

### Note

- Playback image may freeze momentarily using this function. However, this does not affect the recording.
- The 2x fast forward playback is not available.
- **This function is available only when you are recording on a DVD-RW in VR mode, with the recording mode LP, EP or SLP.**
- Only the titles (chapters) in the original can be selected. You cannot select titles from the title list.
- When you stop the playback after the timer recording is completed, the unit will be switched to the timer standby mode if another program has been set (refer to "Hints for Timer Recording" on page 42).

# SEARCH

## Title/Chapter Search



Using [SKIP ◀◀] / [SKIP ▶▶]

Press [DVD] first.

- 1) During playback, press [SKIP ▶▶] to skip the current title or chapter and move to the next.  
The title or chapter will move forward by one at a time.
  - If there is no chapter in one title, the current title will be skipped.To go back to the beginning of the current title or chapter, press [SKIP ◀◀].  
Press it twice in quick successions to go to the previous title or chapter. The title or chapter will move backward one title at a time.

## Using [DISPLAY]

Press [DVD] first.

- 1) During playback, press [DISPLAY].
- 2) Use [◀/▶] to select , then press [ENTER].  
e.g.) DVD-video

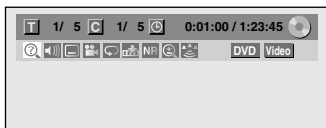

The number next to **T** will be highlighted.

### 3) Title:

Use [▲ / ▼] or [the Number buttons] to enter a desired title number to search, then press [ENTER].  
Title search will start.

### Chapter:

Press [▶] to move to the number next to **C** for chapter.

Use [▲ / ▼] or [the Number buttons] to enter a desired chapter number to search, then press [ENTER].

After the search, playback will start automatically.

## Note

- In search mode display, total numbers of each search contents (title/chapter/time) are shown as a denominator.

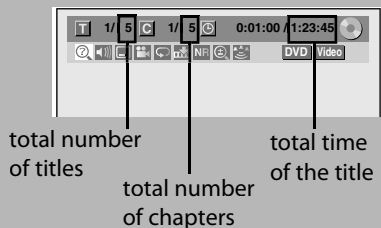

## Track Search



Using [SKIP ◀◀] / [SKIP ▶▶]

Press [DVD] first.

- 1) During playback, press [SKIP ▶▶] to skip the current track/file and move to the next.  
The track/file will move forward one at a time.  
To go back to the beginning of the current track/file, press [SKIP ◀◀].  
(For JPEG files, press it once to go to the previous file.)  
Press it twice in quick successions to go to the previous track/file. The track/file will move backward one at a time.

## Using [DISPLAY]

Press [DVD] first.

- 1) During playback, press [DISPLAY] to bring up the display menu.  
If the display menu is already shown, skip to step 2.
- 2) Use [◀/▶] to select , then press [ENTER].  
e.g.) audio CD

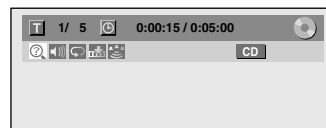

e.g.) MP3 files

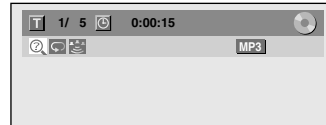

The number next to **T** will be highlighted.

- 3) Use [▲ / ▼] or [the Number buttons] to enter a desired track/file number to search, then press [ENTER].  
After the search, playback will start automatically.

## Note

- During CD playback, you can enter a track number directly using [the Number buttons] for track search without displaying the menu.



## Time Search



Press [DVD] first.

1) During playback, press [DISPLAY] to bring up the display menu.  
If the display menu is already shown, skip to step 2.

2) Use [◀/▶] to select , then press [ENTER].

e.g.) DVD-video

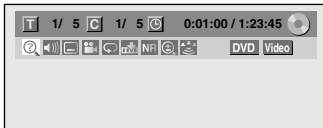

e.g.) audio CD

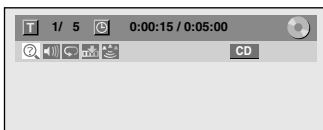

The number next to will be highlighted.

To move to the number next to , press [▶].

When time search is not available, and time counter are not displayed.

3) Use [▲ / ▼ / ◀ / ▶] or [the Number buttons] to enter a desired time to search, then press [ENTER].

After the search, playback will start automatically.

### Note

- Time search is available only in the same track, file or title.

## Repeat Playback

Available repeat function may vary depending the discs.

**Press [DVD] first.**

- 1) During playback, press [DISPLAY] or [REPEAT] to bring up the display menu.  
If the display menu is already shown, skip to step 2.  
• If you press [REPEAT], skip to step 3.

- 2) Use [◀/▶] to select  to display the selection menu.

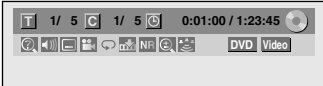

- 3) Use [▲/▼] to select a desired option to repeat, then press [ENTER].

The selected repeat playback will start.

e.g.) DVD-video

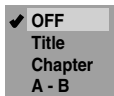

e.g.) audio CD



e.g.) MP3/WMA/JPEG files



e.g.) DivX® files



**Title:**

The current title will be played back repeatedly.

**Chapter:**

The current chapter will be played back repeatedly.

**All:**

The current disc will be played back repeatedly.

**A-B:**

Desired section can be played back repeatedly.

- 1) Use [▲/▼] to select "A-B", then press [ENTER].
- 2) Press [ENTER] at the desired starting point A.
- 3) Press [ENTER] at the desired ending point B.

**Track:**

The current track or file will be played back repeatedly.

**Group:**

The current folder will be played back repeatedly.

## Note

- Point B for the repeat A-B playback should be set within the same title or track of point A.
- To cancel the repeat playback, select "OFF" at step 3. The repeat setting will also be canceled when you stop playback.
- You cannot select "Group" during the random playback of MP3/WMA/JPEG files.
- For some DivX® files, A-B repeat playback may not function.
- Chapter/Track repeat will be canceled whenever a Chapter/Track is skipped forward or backward.
- During the A-B repeat, if you reaches the point A with any reverse playback, the reverse playback will be canceled and the A-B repeat playback resumes from point A.

## Random Playback



You can play back a disc randomly instead of playing back in the original order.

**Press [DVD] first.**

- 1) Press [SETUP] in stop mode.

- 2) Use [▲/▼] to select "DISC Playback Mode", then press [ENTER].

"DISC Playback Mode" menu will appear.

For MP3/WMA, use [▲/▼] to select "Music", then press [ENTER].

For JPEG, use [▲/▼] to select "Photo", then press [ENTER].

- 3) Use [▲/▼] to select "Random Play", then press [ENTER].

Random playback will start.

e.g.) audio CD

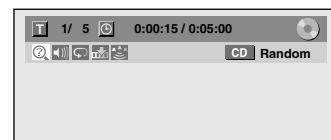

## Note

- To cancel random playback, press [STOP ■] twice during random playback. "OFF" appears on the display menu.

## Program Playback



You can program the disc to play back in your desired order.

**Press [DVD] first.**

- 1) Press [SETUP] in stop mode.
- 2) Use [▲ / ▼] to select "DISC Playback Mode", then press [ENTER].  
"DISC Playback Mode" menu will appear.
- 3) Use [▲ / ▼] to select "Program Play", then press [ENTER].
- 4) Use [▲ / ▼] to select a desired track, then press [ENTER] or [▶].

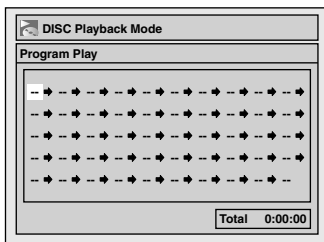

Repeat this step until you program all the desired tracks.

- 5) Press [PLAY ▶].

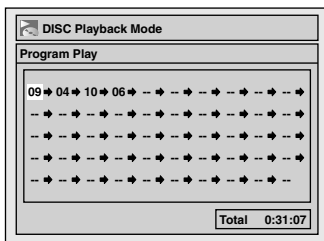

Program playback will start.

### Note

- To erase tracks you selected, press [CLEAR] at step 4.
- You can make program settings up to 50 tracks.
- To cancel program playback, press [STOP ■] twice during program playback. "OFF" appears on the TV screen.
- You may also select a desired track using [the Number buttons] at step 4.

## Slide Show



You can select the display time between 5 seconds and 10 seconds.

**Press [DVD] first.**

- 1) Follow steps 1 and 2 in "Program Playback" on the left.
- 2) Use [▲ / ▼] to select "Photo", then press [ENTER].
- 3) Use [▲ / ▼] to select "Slide Show", then press [ENTER].
- 4) Use [▲ / ▼] to select the display time, then press [ENTER].
- 5) Press [SETUP] to exit.

### Note

- Large-size JPEG files take a few moments to be displayed.

# SELECTING THE FORMAT OF AUDIO AND VIDEO

You can select the format of audio and video as you prefer depending on the contents of the disc you are playing back.

## Switching Subtitles



DVD-video may have subtitles in one or more languages. Available subtitle languages can be found on the disc case. You can switch subtitle languages during playback.

**Press [DVD] first.**

1) **During playback, press [DISPLAY].**

2) Use [◀/▶] to select  to display the selection menu.

e.g.) DVD-video

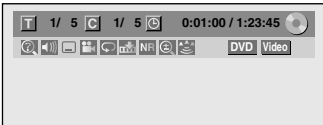

3) Use [▲/▼] to select a desired subtitle language, then press [ENTER].

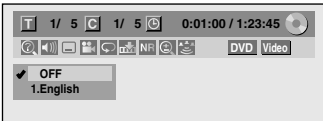

Subtitle will be displayed in the selected language. When "OFF" is selected, subtitle will disappear.

### Note

- Some discs will only allow you to change the subtitle from the disc menu. Press [DISC MENU] or [TOP MENU] to display the disc menu.
- If a 4-digit language code appears in the subtitle menu, refer to the "LANGUAGE CODE" on page 107.
- For disc with DivX® files, the TV screen only displays the number of subtitle languages and " - - - " next to the numbers.

## Switching Audio Soundtrack



When playing back a DVD-video recorded with 2 or more soundtracks (these are often in different languages), you can switch them during playback.

When playing back audio CD, you can switch "L/R"(stereo), "L"(left) or "R"(right).

**Press [DVD] first.**

1) **During playback, press [DISPLAY] or [AUDIO] to bring up the display menu.**

**If the display menu is already shown, skip to step 2.**

- If you press [AUDIO], skip to step3.

2) Use [◀/▶] to select  to display the selection menu.

3) Use [▲/▼] to select a desired audio soundtrack or audio channel, then press [ENTER].

For DVD-video, VR mode DVD-RW, or DivX® files

- Audio soundtrack will switch.

e.g.) DVD-video

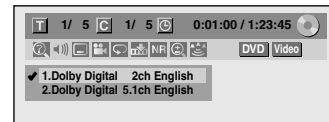

- If the title contains both main and sub audio, you can further select "L" (main), "R" (sub), "L/R" (mixed of main and sub).

For audio CD

- Audio channel will switch.

e.g.) audio CD

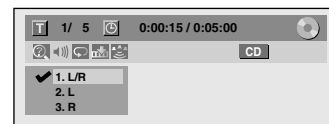

### Note

- Some discs will only allow you to change the soundtrack from the disc menu. Press [DISC MENU] or [TOP MENU] to display the disc menu.

## Switching Virtual Surround System



You can enjoy stereophonic virtual space through your existing 2 channel stereo system.

**Press [DVD] first.**

1) During playback, press [DISPLAY] to bring up the display menu.

If the display menu is already shown, skip to step 2.

2) Use [◀/▶] to select to display the selection menu.

e.g.) DVD-video

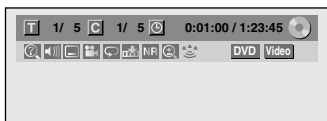

3) Use [▲/▼] to select "OFF", "Type 1" or "Type 2", then press [ENTER].

e.g.) DVD-video

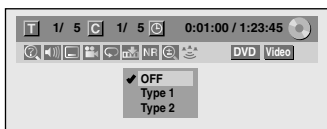

**OFF** : no effect

**Type 1** : natural effect

**Type 2** : emphasized effect

### Note

- Select "OFF" if sound is distorted.
- The setting will be kept when the unit is turned off.

## Switching Camera Angles



Some DVD-video have scenes shot from two or more angles. Angle information should be on the disc case if the disc contains multi-angle scenes.

**Press [DVD] first.**

1) During playback, press [DISPLAY].

2) Use [◀/▶] to select , then press [ENTER].

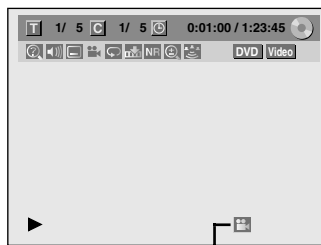

Angle icon appears when a switching camera angle is available. Angle will switch each time you press [ENTER].

### Note

- Angle icon does not appear on the TV screen if you set "Angle Icon" to "OFF" in "Playback" menu. Refer to page 91.

## Reducing Block Noise



**Press [DVD] first.**

1) During playback, press [DISPLAY].

2) Use [◀/▶] to select to display the selection menu.

e.g.) DVD-video

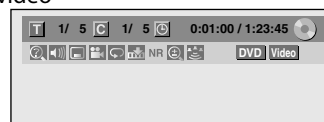

3) Use [▲/▼] to, select "Noise Reduction", then press [ENTER].

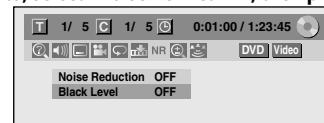

4) Use [▲/▼] to select a desired option, then press [ENTER].

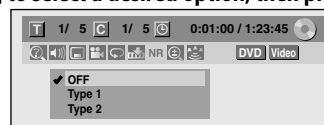

Your setting will be activated.

This function reduces noise in the playback picture. If noises appear on the TV screen during playing back discs recorded in long time recording mode such as EP or SLP, select "Type 1" or "Type 2".

("Type 2" is more effective.)

When playing back discs with a few noises such as DVD-video, select "OFF".

## Adjusting Black Level



You can adjust the black level to control the brightness of the picture in order to get a better picture.

1) During playback, press [DISPLAY].

2) Use [◀/▶] to select **NR** to display the selection menu.

e.g.) DVD-video

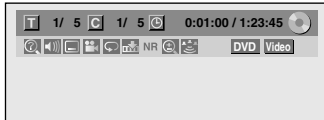

3) Use [▲/▼] to select "Black Level", then press [ENTER].

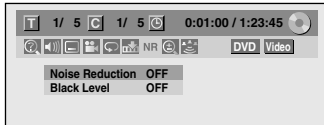

4) Use [▲/▼] to select "OFF" or "ON", then press [ENTER].

Your setting will be activated.

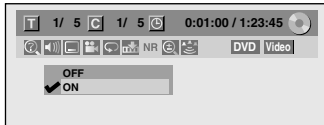

**OFF** : Shows the original picture as recorded.

**ON** : Make the darker parts of the picture more visible.

### Note

- You can adjust black level setting only during playback.
- The setting will be kept even when the unit is turned off.
- The default setting is "ON".

## Guide to a Title List

Title list allows you to check the titles recorded on the disc easily. You can choose a title to play back from this list and easily edit the titles as you prefer.

Press [TOP MENU].

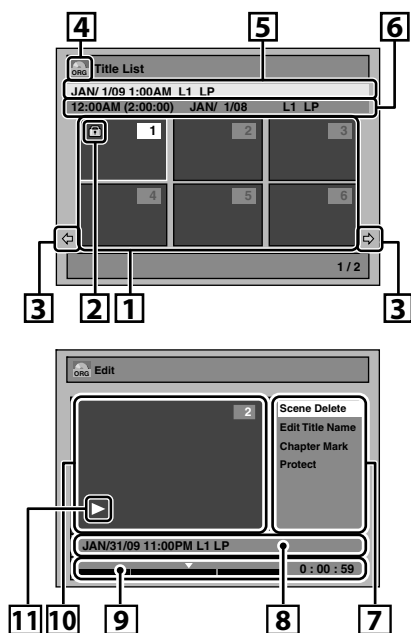

1. **Title list:** List of the titles recorded on the disc, and their information.
  - For DVD+RW/+R, empty title always appears at the last of the title list.
  - For the titles being blocked by the V-chip system, "BLOCK" will be displayed and you cannot watch the contents.
2. **The protect icon:** Appears when the title has been protected. (Original titles only)
3. **Arrow:** Indicating there is a previous / next page.
4. **Title list icon:** Indicates a type of the displayed title list.
 

: VR (Original)	: +VR mode
: VR (Playlist)	: Video mode
5. **Title name**
6. **Title information:** Displays various information on the selected title.
7. **Submenu:** Submenus for the selected menu are displayed here.
8. **Title name (editable):** If you do not name the title, the recorded date, time and the recording mode are displayed here.
9. **Progress bar:** Indicating the progress of the playback. The vertical lines in the bar indicates chapter marks, and "▼" sliding on the bar indicates current point of playback displayed in the preview window.
10. **Preview window:** Preview of the selected title is displayed here.
11. **Playback status:** Indicating the current playback status of the selected title.

Press [RETURN] to exit the title list.

## Editing Discs

### Edit the recorded disc

You will find editing discs is easy. This unit offers convenient edit functions which are possible only with DVD-RW/-R and DVD+RW/+R.

You can edit the following from a title list.

- Assigning a name to a title
- Dividing a title
- Combining titles
- Adding titles to a playlist
- Erasing all playlist
- Setting or releasing the title protection
- Adding or deleting chapter marks
- Deleting titles or parts of titles

(Possible editing functions depend on the recording format and editing method.)

### Original and playlist (VR mode)

For VR mode DVD-RW, you can edit the recordings in playlist without changing the original recordings. Playlist does not take up much disc space. After you make a recording to VR mode DVD-RW, a playlist will be created automatically.

### What "Original" or "Playlist" is for?

Throughout this manual, you will find original and playlist which refer to the actual content and the edited version.

- **Original** content refers to what's actually recorded on the VR mode DVD-RW.
  - **Playlist** content refers to the edited version of the VR mode DVD-RW; how the original content is to be played back.
- ### Finalizing a disc
- This will allow a disc that is recorded on this unit to be played back on other DVD player — without finalization it will not be playable on other DVD player.
  - After finalizing a DVD-RW/-R or DVD+R, you cannot edit any information that is on that disc.
  - If you have recorded in DVD+RW, then editing is still permitted after finalizing.

**Using these editing functions to modify copyrighted content for any purpose other than your private viewing may be prohibited under the Copyright Laws of the United States and other countries, and may subject you to civil and criminal liability.**

# DELETING TITLES

## Notes for deleting titles

After the disc is fully recorded:

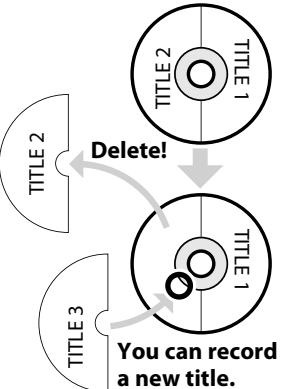
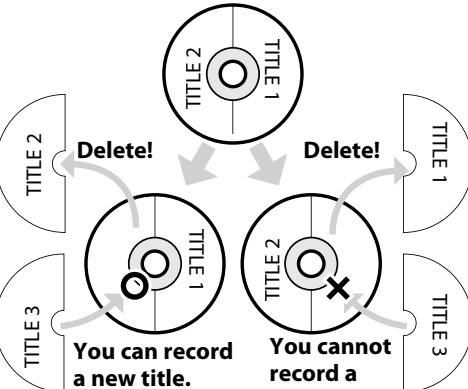
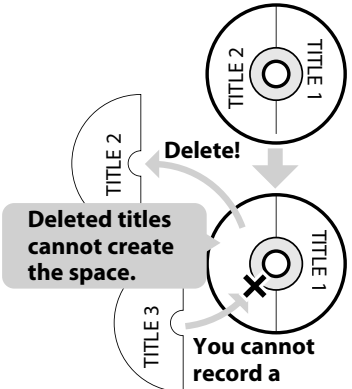
DVD-RW/DVD+RW		DVD-R/DVD+R
<p>• When a title is deleted from DVD-RW in VR mode, the recordable disc space will be increased.</p> <p>The Full-Recorded disc</p> 	<p>• When the last title is deleted from DVD-RW in video mode or DVD+RW, the recordable space will be increased.</p> <p>The Full-Recorded disc</p> 	<p>• When a title is deleted from DVD-R and DVD+R, the recordable space will NOT be increased.</p> <p>The Full-Recorded disc</p> 

Once all editings are made, press **[RETURN]** several times to exit the editing mode. "Writing to Disc" appears momentarily. It also appears when pressing **[▲OPEN/CLOSE]** or **[II/⊕ ON/STANDBY]** before exiting the editing mode after editing.

### Note

- If you delete the title in DVD+RW, deleted title will be displayed as "Empty".
- You cannot overwrite on the "Empty"
- For DVD+RW, if "Empty" appears right next to the other "Empty", those "Empty" combines into one.

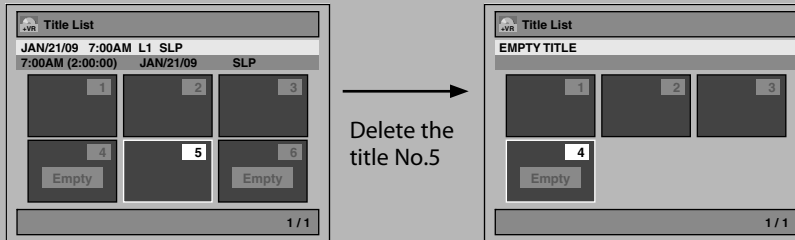



# DELETING TITLES



You can delete titles which you do not need anymore. Please be advised that the titles once deleted cannot be brought back to the disc.  
Be sure to read "Notes for deleting titles" on page 72 before you delete the title.

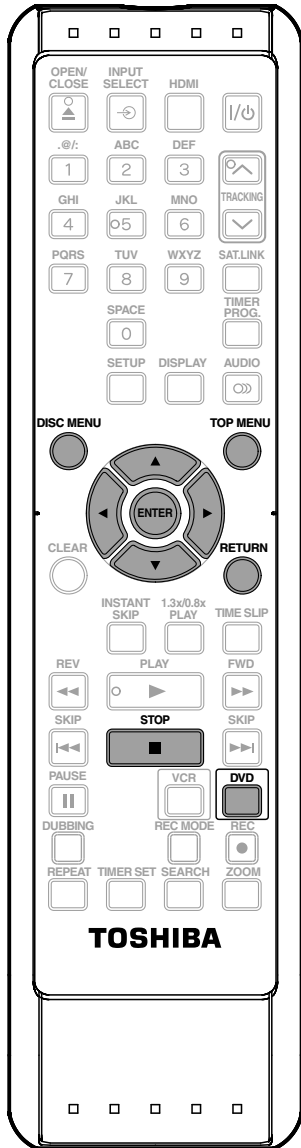

## 1 Press [DVD]. In stop mode, press [TOP MENU].

Title list, original or playlist will appear.  
• For VR mode DVD-RW, press [DISC MENU] to switch between "Original" and "Playlist".

## 2 Use [▲ / ▼ / ◀ / ▶] to select a desired title, then press [ENTER].

e.g.) VR mode DVD-RW original

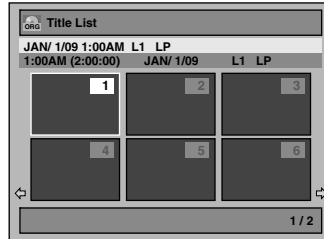

## 3 Use [▲ / ▼] to select "Title Delete", then press [ENTER].

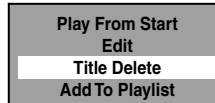

## 4 Use [▲ / ▼] to select "Yes", then press [ENTER].

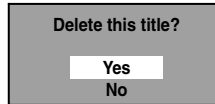

After that, "Are you sure?" will appear, select "Yes" and then press [ENTER].  
Title will be deleted.

## 5 Press [RETURN] or [STOP ■] to exit. Data will be written onto the disc momentarily.



**This operation may take awhile to be completed.**

# CREATING/DELETING PLAYLIST

## Adding Titles to a Playlist



For VR mode DVD-RW, you can create the playlist as you wish.

You can add up to 99 titles to a playlist (as long as the total number of the playlist does not exceed 999 chapters).

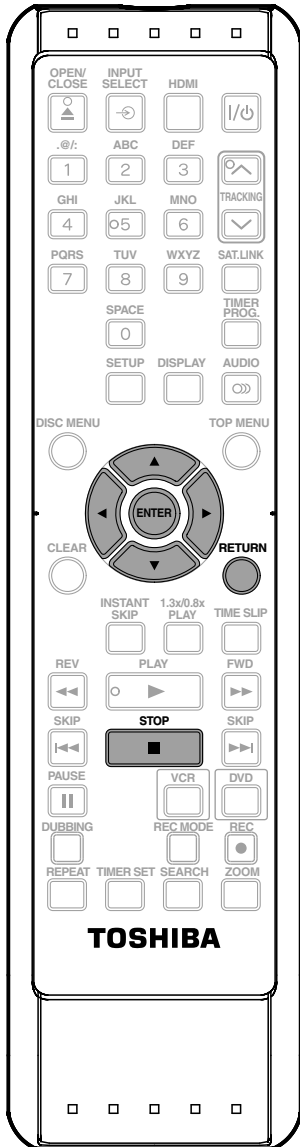

**1** Follow the step 1 in “DELETING TITLES” on page 73 to display the original.

**2** Use [▲ / ▼ / ◀ / ▶] to select the desired title, then press [ENTER].

**3** Use [▲ / ▼] to select “Add To Playlist”, then press [ENTER].

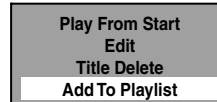

**4** Use [▲ / ▼] to select “Yes”, then press [ENTER].

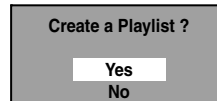

The title is added to playlist.

**5** Press [RETURN] or [STOP ■] to exit. Data will be written onto the disc momentarily.

**This operation may take awhile to be completed.**

### Note

- When a playlist contains 99 titles or more, or 999 chapters or more, “Add to Playlist” cannot be selected.

## Erasing All Playlist



A playlist can be deleted if it is no longer needed.

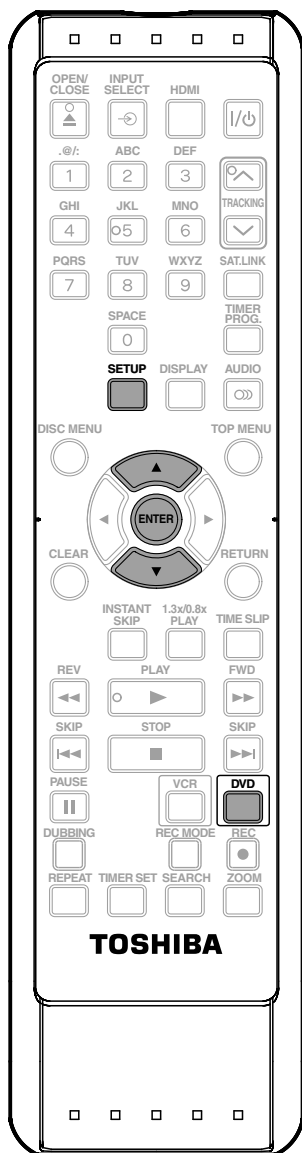

**1** Press [DVD].  
Press [SETUP].  
Main menu will appear.

**2** Use [▲ / ▼] to select “DVD Menu”,  
then press [ENTER].

**3** Use [▲ / ▼] to select “Delete All  
Playlists”, then press [ENTER].

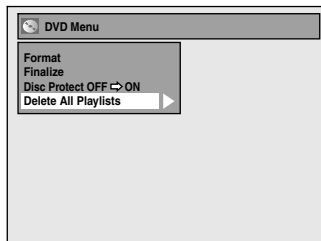

**4** Use [▲ / ▼] to select “Yes”, then press [ENTER].

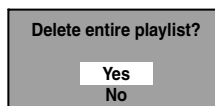

“Are you sure?” will appear.  
Use [▲ / ▼] to select “Yes” and then press [ENTER].

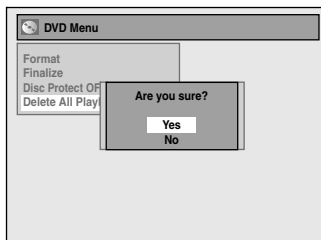

Playlist is deleted.  
Data will be written onto the disc momentarily.

**This operation may take awhile to be completed.**

### Note

- Deleting a playlist will not increase the available recording time on the disc.

# EDITING DISCS

## Putting Names on Titles



You can put a name on the title and change it from this menu.

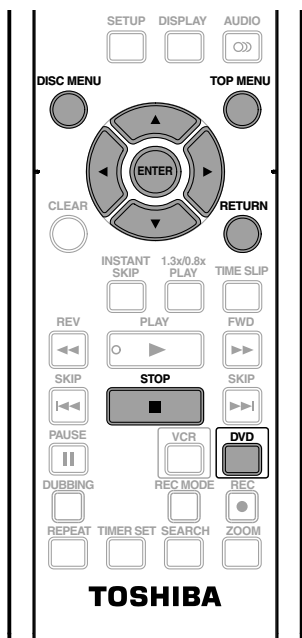

### 1 Press [DVD]. In stop mode, press [TOP MENU].

Title list, original or playlist will appear.  
• For VR mode DVD-RW, press [DISC MENU] to switch between "Original" and "Playlist".

### 2 Use [▲ / ▼ / ◀ / ▶] to select a desired title, then press [ENTER]. e.g.) VR mode DVD-RW original

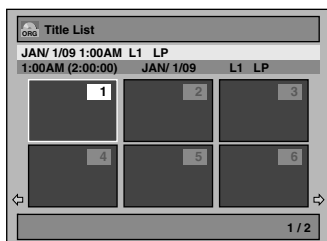

### 3 Use [▲ / ▼] to select "Edit", then press [ENTER].



### 4 Use [▲ / ▼] to select "Edit Title Name", then press [ENTER].

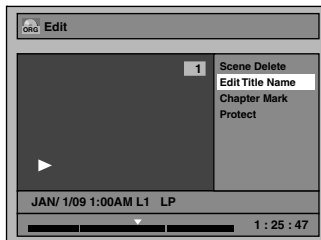

### 5 To enter a title name, follow the steps of "Guide to Edit Title Name" on page 77.

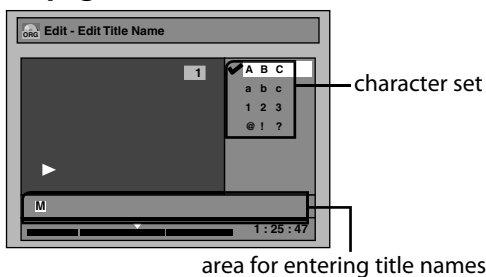

When you finish entering a title name, press [ENTER].

### 6 Use [▲ / ▼] to select "Yes", then press [ENTER].

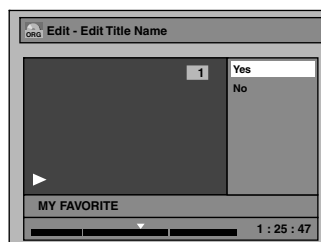

The name you entered will be activated for the title.

### 7 Press [RETURN] and then [RETURN] or [STOP ■] to exit.

Data will be written onto the disc momentarily.

**This operation may take awhile to be completed.**

## Putting Names on Titles (cont'd)

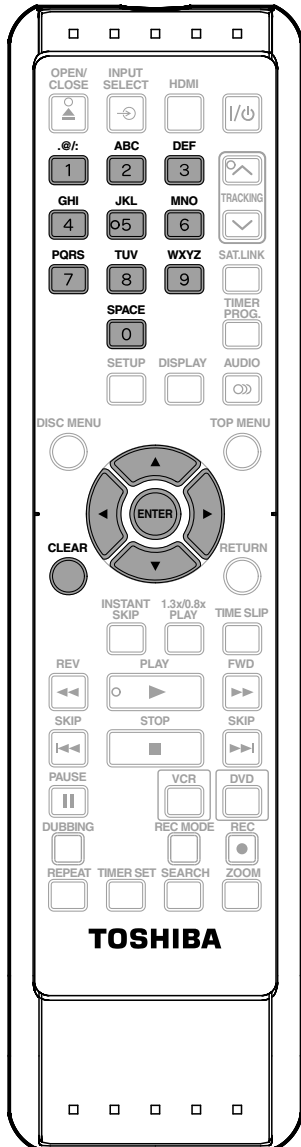

### Guide to Edit Title Name

- 1) Use [▲ / ▼] to select a desired character set, then press [ENTER].
- 2) Follow the list below, use [the Number buttons] repeatedly until the desired letter appears.

Select Press	ABC	abc	123	@!?
0	<space>	<space>	0	<space>
1	(*1)	(*1)	1	!"#\$%&'()* *+,-./:;<=> ?@[ ]^_`{ }
2	ABC	abc	2	-
3	DEF	def	3	-
4	GHI	ghi	4	-
5	JKL	jkl	5	-
6	MNO	mno	6	-
7	PQRS	pqrs	7	-
8	TUV	tuv	8	-
9	WXYZ	wxyz	9	-

- \*1 Press **1**, character set will be changed to the “@!?” mode automatically.
- To delete letters, press [CLEAR] repeatedly. Press and hold [CLEAR] to delete all letters.
  - Use [◀ / ▶] to move the cursor to the left and right.
  - You can enter up to 30 letters.

### Note

- Undefined letters in a title name are shown by “\*” . If you delete them, adjoining letters may change to “\*” or other.

## Setting Chapter Marks



You can put chapter marks in each title. Once a chapter is marked, you can use it for the chapter search feature.

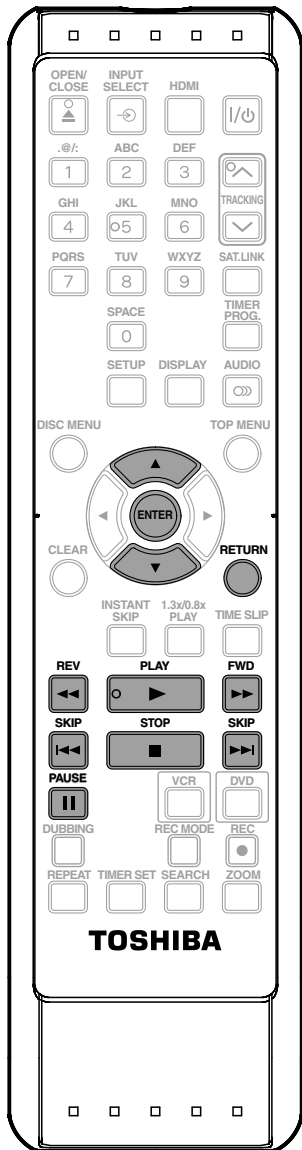

- 1** Follow steps 1 to 3 in “Putting Names on Titles” on page 76 to display “Edit” menu.
- 2** Use [▲ / ▼] to select “Chapter Mark”, then press [ENTER].  
Submenu will appear.
- 3** Use [SKIP |◀◀ / ▶▶|], [REV ◀◀], [FWD ▶▶], [PLAY ▶] and [PAUSE ||] to find the point where you will create a new chapter mark.  
Or, use [SKIP |◀◀ / ▶▶|] to find a chapter mark that you wish to delete.
- 4** Use [▲ / ▼] to select “Add” or “Delete”, then press [ENTER].  
e.g.) VR mode DVD-RW original
- 5** Use [▲ / ▼] to select “Yes”, then press [ENTER].  
If you select “Add” at step 4, a new chapter mark will be added, and if you select “Delete” at step 4, the chapter mark will be deleted.  
e.g.) Add

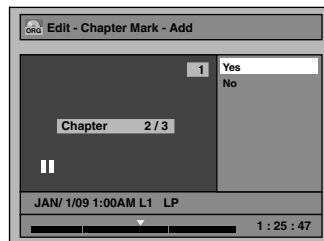
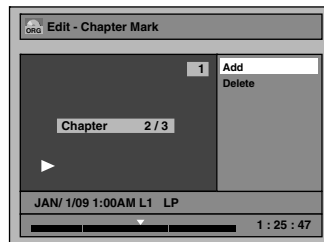

A new chapter mark will be added.

- 6** Press [RETURN].
- 7** Press [RETURN] again and then [RETURN] or [STOP ■] to exit.  
Data will be written onto the disc momentarily.

**This operation may take awhile to be completed.**

### Note

- Maximum numbers of chapter for each DVD:  
VR mode DVD : 999 chapters per entire original and playlist  
+VR mode DVD : 254 chapters per disc, 99 chapters per title
- Besides the above-mentioned, it is not likely to be able to add according to recorded time and number of chapters.

## Hiding Chapters



You can hide chapters from the title list.  
Hidden chapters are skipped during playback.

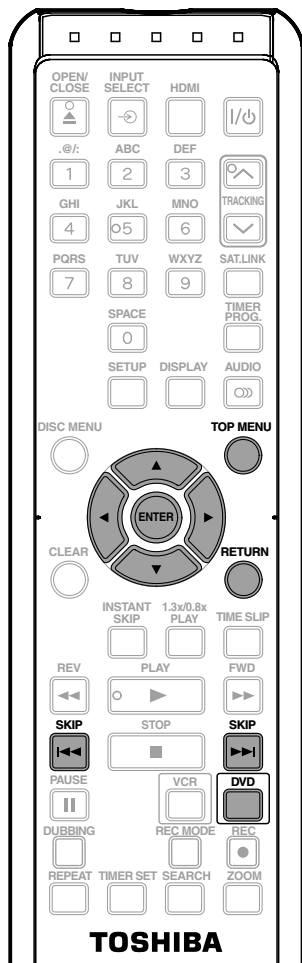

**TOSHIBA**

- 1 Press [DVD].**  
**In stop mode, press [TOP MENU].**  
Title list will appear.

### Note

- "Hidden" will be displayed in the preview window while previewing the hidden chapter.
- When you make all chapters in the title "Hidden", "Hidden" is displayed in a thumbnail of the title list.



- 2 Use [▲ / ▼ / ◀ / ▶] to select a desired title, then press [ENTER].**

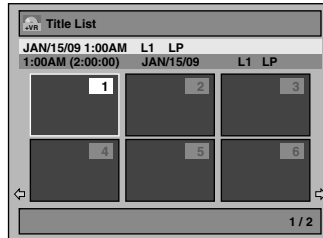

- 3 Use [▲ / ▼] to select "Edit", then press [ENTER].**



- 4 Use [▲ / ▼] to select "Hide Chapter", then press [ENTER].**  
Submenu will appear.

- 5 Use [SKIP ◀◀] or [SKIP ▶▶] to decide the chapter to be hidden.**

- 6 Use [▲ / ▼] to select "Hidden", then press [ENTER].**

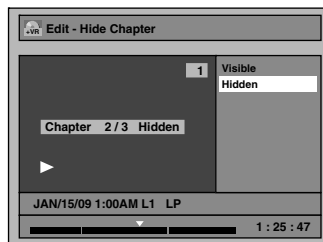

- 7 After this operation is completed, press [RETURN] thrice to exit.**  
Data will be written onto the disc momentarily.

**This operation may take awhile to be completed.**

If you want hidden chapters to be "Visible", select the chapter to be shown. Then use [▲ / ▼] to select "Visible", then press [ENTER] at the step 6 above.

Data will be written onto the disc momentarily.

## Deleting a Part of a Title



You can delete a specific part of a title.  
Even when parts of title are deleted from the playlist, the original title will remain as it is.

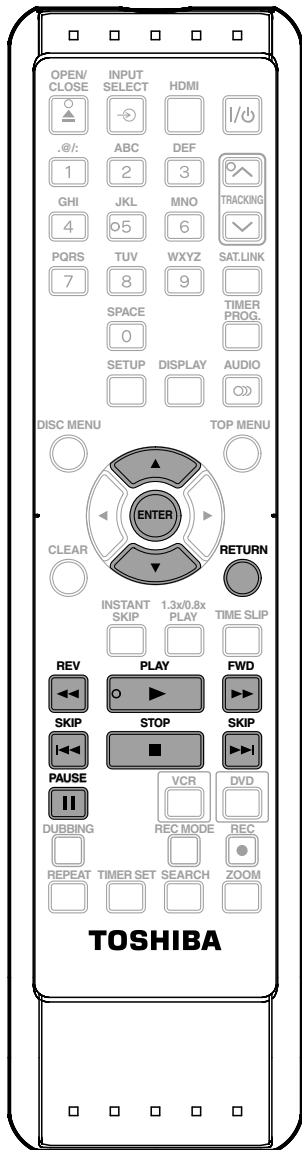

**1** Follow the steps 1 to 3 in “Putting Names on Titles” on page 76 to display “Edit” menu.

**2** Use [▲ / ▼] to select “Scene Delete”, then press [ENTER].  
e.g.) VR mode DVD-RW playlist.

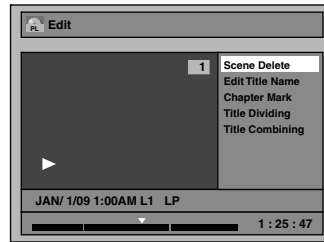

Instructions continue on the next page.

### Note

- When a scene is deleted from an original, the playlist related to the original will be deleted.
- You cannot select “Scene Delete” if the number of chapter marks in the original or playlist is more than 999. (Depends on the content, there is a case that you cannot select “Scene Delete” before the number of chapter marks reaches 999.)
- The recordable disc space will not increase even after deleting a part of a title on the playlist.



## Deleting a Part of a Title (cont'd)

- 3** Use [SKIP |◀◀ / ▶▶|], [REV ◀◀], [FWD ▶▶], [PLAY ▶] and [PAUSE ||] to find the start point, then press [ENTER].

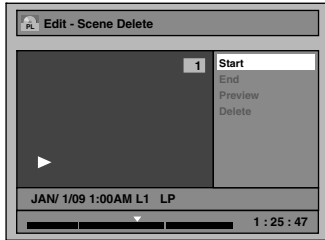

Then use [SKIP |◀◀ / ▶▶|], [REV ◀◀], [FWD ▶▶], [PLAY ▶] and [PAUSE ||] again to move to the end point, and press [ENTER].

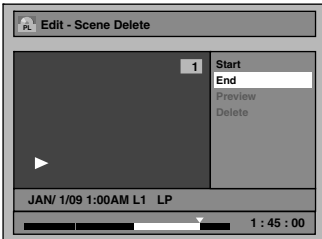

The cursor will move to "Preview".

The bar at the bottom of the screen indicates the total and the elapsed time of the title, and the area selected for deletion is indicated in red.

You can check the preview by pressing [ENTER].

- Before and after 5 seconds of the deleted point will be playback for preview.

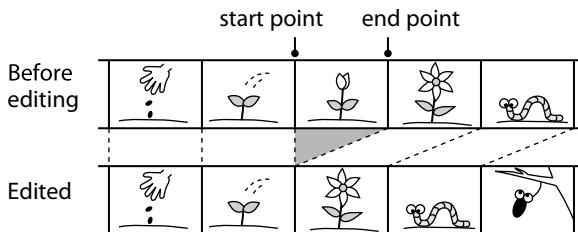

- 4** Use [▲ / ▼] to select "Delete" then press [ENTER].

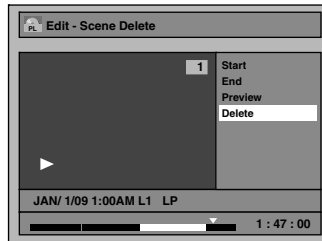

- 5** Use [▲ / ▼] to select "Yes" then press [ENTER].

"Are you sure?" will appear. Select "Yes" using [▲ / ▼] and then press [ENTER].

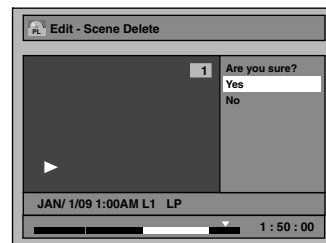

The part of the title is deleted.

- 6** Press [RETURN] and then [RETURN] or [STOP ■] to exit.

Data will be written onto the disc momentarily.

**This operation may take awhile to be completed.**

## Dividing a Title



You can divide one title into two new titles.

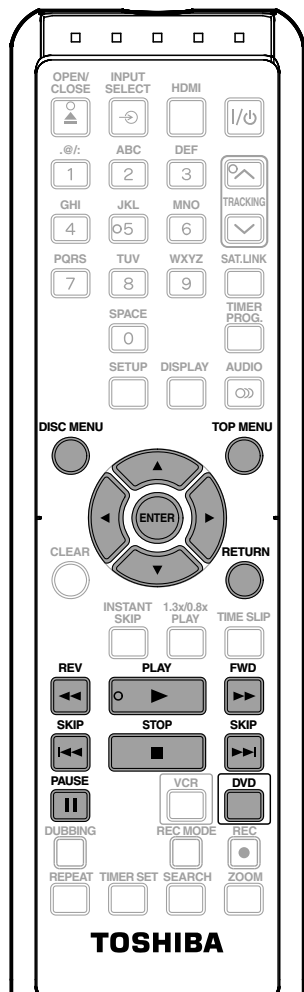

**1** Press [DVD].  
**In stop mode, press [TOP MENU].**  
 • For VR mode DVD-RW, press [DISC MENU] to select "Playlist".

**2** Use [▲ / ▼ / ◀ / ▶] to select a desired title, then press [ENTER].

### Note

• You cannot divide a title of the disc when the number of recording titles reaches the maximum of 99 (-RW) or 49 (+RW), and the number of recording chapters reaches the maximum of 999 (-RW) or 254 (+RW).

**3** Use [▲ / ▼] to select "Edit", then press [ENTER].  
 e.g.) VR mode DVD-RW playlist

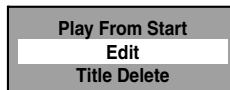

**4** Use [SKIP ◀◀], [SKIP ▶▶], [REV ◀◀], [FWD ▶▶], [PAUSE ||] and [PLAY ▶] to decide the point at which you will divide the title.

**5** Use [▲ / ▼] to select "Title Dividing", then press [ENTER].

**6** Use [▲ / ▼] to select "Yes", then press [ENTER].  
 e.g.) VR mode DVD-RW playlist

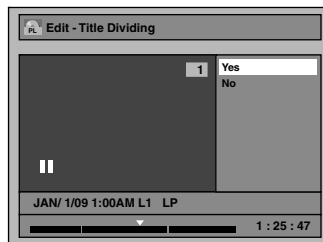

The title will be divided into two new titles.  
 Both title names are identical.

For DVD+RW: Data will be written onto the disc momentarily.



**This operation may take awhile to be completed.**

For VR mode DVD-RW: Proceed to step 7.

**7** Press [RETURN] or [STOP ■] to exit.

Data will be written onto the disc momentarily.

**This operation may take awhile to be completed.**

## Combining Titles



You can combine two titles into a single title.

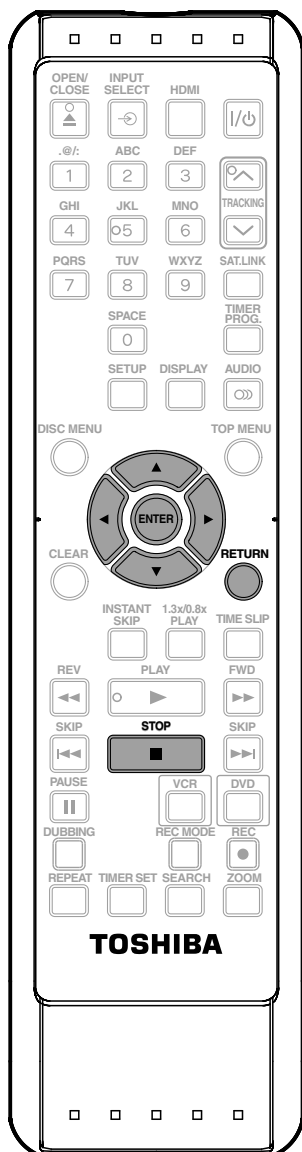

### Note

- You cannot select the same title twice and combine it into a single title.
- If either one of the two original titles is deleted, the combined new title is also deleted.

**1** Follow the steps 1 to 3 in “Dividing a Title” on page 82 to display “Edit” menu.

**2** Use [▲ / ▼] to select “Title Combining”, then press [ENTER].

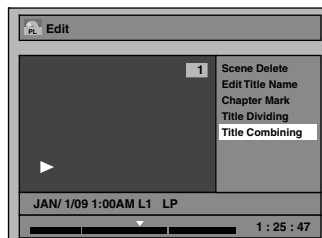

Title combining setting window will appear. Selected title grays out, and the frame of the next title becomes yellow.

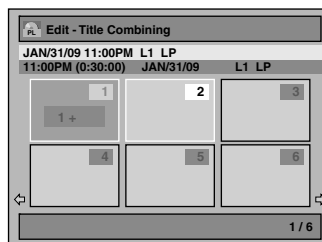

**3** Use [▲ / ▼ / ◀▶] to select another title to combine, then press [ENTER]. Selection menu will appear.

**4** Use [▲ / ▼] to select “Yes”, then press [ENTER].

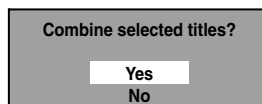

The two titles will combine into a single title.

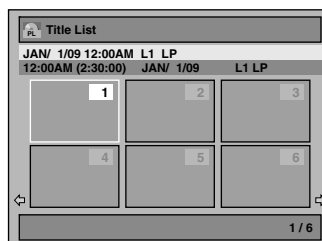

**5** Press [RETURN] or [STOP ■] to exit. Data will be written onto the disc momentarily.

**This operation may take awhile to be completed.**

## Setting or Releasing the Title Protection



To prevent the accidental editing, or erasing of the titles, you can protect them in "Edit" menu.

You can cancel the title protection feature after it is applied.

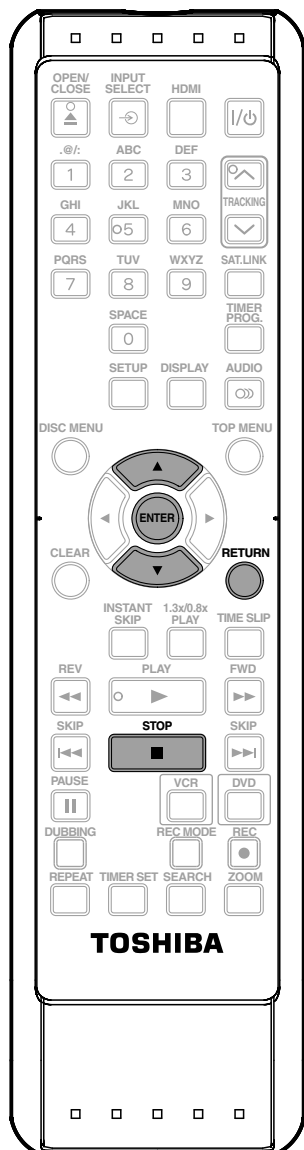

**1** Follow the steps 1 to 3 in "Putting Names on Titles" on page 76 to display "Edit" menu.

**2** Use [▲ / ▼] to select "Protect", then press [ENTER].

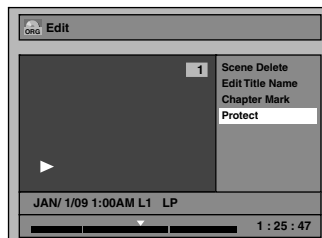

- If the title is protected, icon will appear in the original list.

**3** Confirm the indication "OFF ⇒ ON". Press [ENTER] again.

- If the title is already protected, "ON ⇒ OFF" will appear. If you press [ENTER], the title will be released from protection.

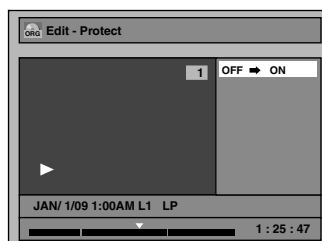

- icon will appear on the title in the original list.

**4** Press [RETURN] and then [RETURN] or [STOP ■] to exit.  
Data will be written onto the disc momentarily.

**This operation may take awhile to be completed.**

**To protect a whole disc (VR mode DVD-RW, DVD+RW/+R only):**

Select "Disc Protect OFF ⇒ ON" from the DVD Menu, then select "Yes".

Refer to "SETTING A DISC TO PROTECT" on page 30.

## Setting or Clearing All Chapter Marks at Once



For titles in video mode DVD-RW, you can set or edit chapter at every time interval. You can clear the chapter mark too.

You can specify the interval of chapter marks for titles last more than 5 minutes.

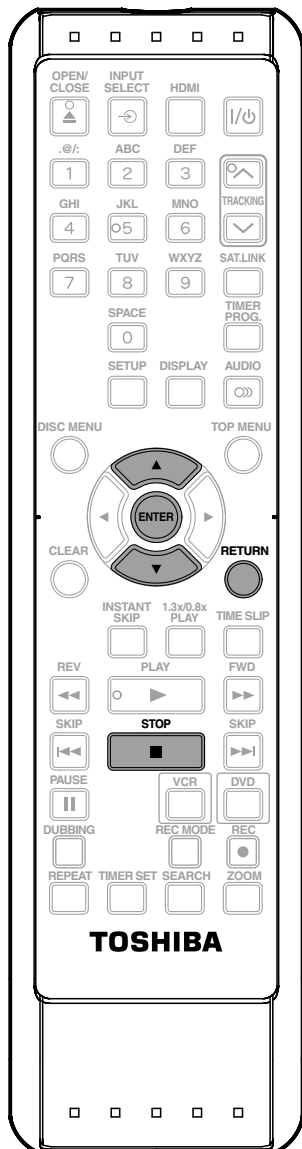

**1** Follow the steps 1 to 3 in “Putting Names on Titles” on page 76 to display “Edit” menu.

**2** Use [▲ / ▼] to select “Chapter Mark”, then press [ENTER].

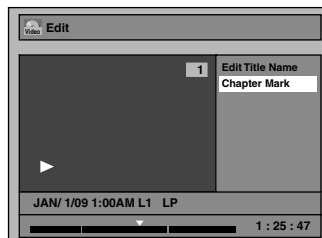

**3** Use [▲ / ▼] to select the desired interval, then press [ENTER].

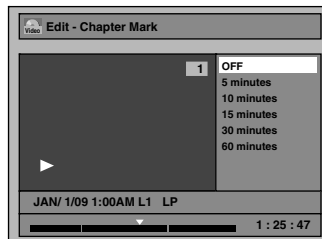

**4** Use [▲ / ▼] to select “Yes”, then press [ENTER].

Chapter marks are added.

If you select “OFF” at step 3, all the chapter marks are erased.

**5** Press [RETURN] and then [RETURN] or [STOP ■] to exit.

Data will be written onto the disc momentarily.

**This operation may take awhile to be completed.**

### Note

- You cannot select a chapter mark interval that exceeds the length of a title.
- The length of chapters may slightly deviate from the one specified at the step 3.
- A chapter mark may be delayed depending on the recording content.
- Maximum number of chapter for video mode DVD is 99 chapters per title.
- The interval for auto chapter may be up to two minutes different from the time option you set.

# LIST OF THE DEFAULT SETTINGS

The following table is the contents which you can set and the default settings. Refer to the following table for useful operation.

Setup	Items (highlight is the default)		Contents		
General Setting	Playback → page 89	Parental Lock → page 89	OFF level 8 [Adult] to 1 [Kid Safe]	Set the parental level for DVD playback.	
		Audio Out → page 90	Dynamic Range Control	ON OFF	Compressing the range of sound volume.
			PCM	48kHz 96kHz	Set whether the sound recorded in 96kHz will be down sampled to 48kHz.
			Dolby Digital	PCM Stream	Set the type of sound signal which outputs from the digital audio output jack.
			DTS	ON OFF	Set whether DTS signal is output or not.
		Disc Menu Language → page 91	English French Spanish Other	Set the language for disc menu language.	
		Audio Language → page 91	Original English French Spanish Other	Set the language for audio.	
	Subtitle Language → page 91	OFF English French Spanish Other	Set the language for subtitles.		
	Angle Icon → page 91	ON OFF	Set whether to display the angle icon or not.		
	Still Mode → page 91	Auto Field Frame	Set the type of still image in pausing playback.		
Display	OSD Language → page 92	English Français Español	Set the language for OSD (on-screen display).		
	Screen Saver → page 92	OFF 1 minute 5 minutes 10 minutes 15 minutes	Set the idling time before the screen saver starts.		
	FL Dimmer → page 92	Auto Bright Dark	Set the brightness of the front panel display.		
	V-Chip	MPAA Rating → page 93	X NC-17 R PG-13 PG G NR	Set the viewing limitation according to US movie ratings.	
		TV Rating → page 93	TV-MA TV-14 TV-PG TV-G TV-Y7 TV-Y None	Set the viewing limitation according to US TV program ratings.	
Canadian English Rating → page 93		18+ 14+ PG G C8+ C E	Set the viewing limitation according to Canadian English language ratings.		

# LIST OF THE DEFAULT SETTINGS

Setup	Items (highlight is the default)		Contents	
Display	V-Chip → page 94	Canadian French Rating → page 94	18ans+ 16ans+ 13ans+ 8ans+ G E	Set the viewing limitation according to Canadian French language ratings.
		Change Password → page 94		Change the password.
Video	Progressive → page 95		ON OFF	Set to the progressive scan mode (set to "ON") or to the interlace scan mode (set to "OFF").
	TV Aspect → page 95		4:3 Letter Box 4:3 Pan & Scan 16:9 Wide	Set a picture size according to aspect ratio of your TV.
	Select Video - L1 (Rear) → page 27		Video In S-Video In	Set the video input type for the external input.
Recording	Auto Chapter → page 35		OFF 5 minutes 10 minutes 15 minutes 30 minutes 60 minutes	Insert chapter marks at even time interval.
	Recording Audio Select (XP) → page 36		PCM Dolby Digital	Set the recording audio type. (Only when the rec mode is set to XP.)
	Auto Finalize → page 31	Disc Full End of Timer Rec	ON OFF ON OFF	Set the unit to finalize the disc automatically.
	Aspect Ratio (Video mode) → page 36		Auto 4:3 16:9	Set a aspect ratio for video mode recording.
	Dubbing Mode → pages 50-51		VCR → DVD DVD → VCR	Set the VCR to DVD (DVD to VCR) duplication.
	Make Recording Compatible → page 35		ON OFF	Set to prohibit additional recording (OFF) or to replace the title list after recording (ON).
Clock	Clock Setting → page 26			Set the clock.
DivX	DivX®VOD → page 96			Provide DivX®VOD registration code.
	DivX Subtitle → page 96		OFF English French Spanish German Italian Swedish Dutch Russian1 Russian2 Hungarian Polish Czech	Set the language for DivX® Subtitle.
HDMI	Format → page 97		RGB YCbCr	Set the color space for the HDMI output.
	HDMI Audio → page 98		ON OFF	Set whether to output the HDMI audio signal or not.
	RGB Range → page 98		Normal Enhanced	Set the black-white contrast level for HDMI RGB output.
Reset All → page 99		Yes No		Set to the default setting.

General Setting

## Note

- Your change to each setting stays on even when the power is off.
- An item which is not currently available is grayed in the settings.

Introduction

Connections

Basic Setup

Disc Management

Recording

Playback

Editing

Function Setup

VCR Function

Others

# GENERAL SETTING

## Playback

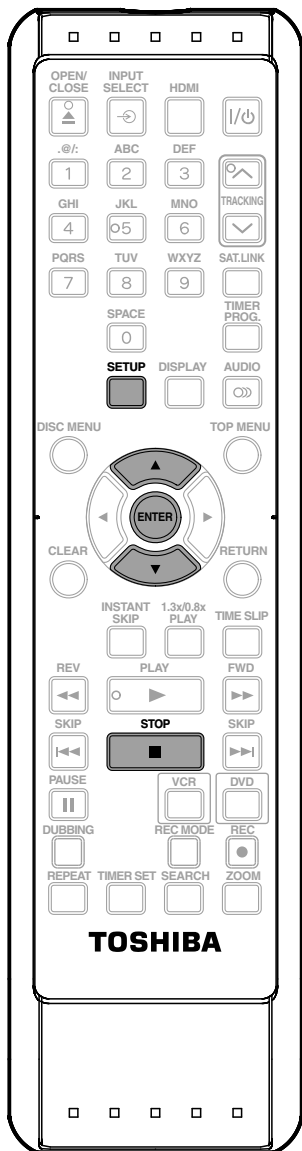

Press [STOP ■] if you are playing back a disc.

**1** Press [SETUP] and use [▲ / ▼] to select "General Setting", then press [ENTER].

**2** Use [▲ / ▼] to select "Playback", then press [ENTER].

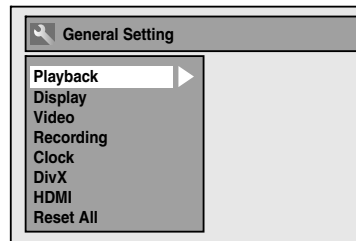

**3** Use [▲ / ▼] to select a desired item, then press [ENTER].

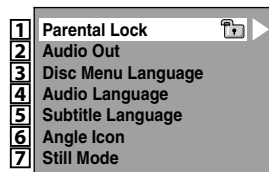

Submenu will appear.

**4** Refer **1** to **7** on pages 89 to 91 and set the selected item.

**5** When you finish with the setting, press [SETUP] to exit.



## Playback (cont'd)

### 1 Parental Lock (Default: OFF)

Some DVD-video feature a parental lock level. Playback will stop if the ratings exceed the levels you set, it will require you to enter a password before the disc will playback. This feature prevents your children from viewing inappropriate material.

Use [▲ / ▼] to select the desired level, then press [ENTER].

Parental Lock	
<input checked="" type="checkbox"/>	OFF
<input type="checkbox"/>	8 [Adult]
<input type="checkbox"/>	7 [NC 17]
<input type="checkbox"/>	6 [R]
<input type="checkbox"/>	5 [PG R]
<input type="checkbox"/>	4 [PG 13]
<input type="checkbox"/>	3 [PG]
<input type="checkbox"/>	2 [G]
<input type="checkbox"/>	1 [Kid Safe]

If a password has not been set yet, proceed to **A**.

If a password has been set already, proceed to **B**.

### RATING EXPLANATIONS

- OFF : Parental Control is inactive; all discs can play.
- 8 [Adult]: DVD software of any grades (adult/general/children) can be played back.
- 7 [NC 17]: No one under 17 admitted.
- 6 [R]: Restricted; under 17 requires accompanying parent or adult guardian.
- 5 [PG R]: Parental Guidance Recommended.
- 4 [PG13]: Unsuitable for children under 13.
- 3 [PG]: Parental Guidance suggested.
- 2 [G]: General Audience.
- 1 [Kid Safe]: Suitable for children.

### Note

- Parental lock function may not be available to some discs.
- With some DVD, it may be difficult to find if they are compatible with parental lock. Be sure to check if the parental lock function operates in the way that you have set.
- Record the password in case you forget it.
- If there is a DVD in the unit when you set up the parental lock, press [OPEN/CLOSE ▲] to activate the parental lock level.

**A**  A password has not been set yet.

Use [▲ / ▼] to select "Yes", then press [ENTER]. Use [the Number buttons] to enter a new password except for 4737, then press [ENTER].

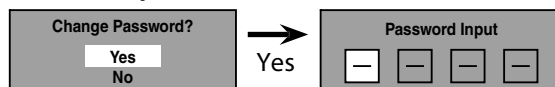

Your setting will be activated.

**B**  A password has been set already.

• Use [the Number buttons] to enter the current password.



Your setting will be activated.

• If you want to change password, use [▲ / ▼] to select "Yes" then press [ENTER]. Use [the Number buttons] to enter a new password except for 4737, then press [ENTER].

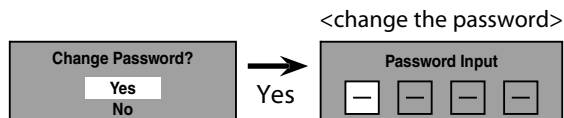

Your setting will be activated.

### Note

- Press [CLEAR] to erase numbers entered incorrectly.
- When you forget the password or you want to clear all settings in "Parental Lock" menu, enter 4737 using [the Number buttons] in password input window. Password will be cleared and parental levels will be set to "OFF".

# GENERAL SETTING

## Playback (cont'd)

### 2 Audio Out

Choose the appropriate audio setting for your external device.  
It will only affect a disc playback.

Use [▲ / ▼] to select a desired item, then press [ENTER].

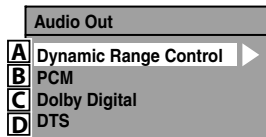

#### A Dynamic Range Control (Default : ON)

Set to "ON" to compress the range between soft and loud sounds.

Use [▲ / ▼] to select a setting, then press [ENTER].

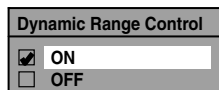

Your setting will be activated.

#### Note

- Dynamic range control function is available only on the discs which are recorded in the Dolby Digital format.

#### B Settings for PCM (Default : 48kHz)

Use [▲ / ▼] to select a setting, then press [ENTER].

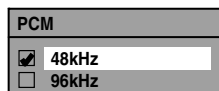

Your setting will be activated.

**48kHz** : If your amplifier/decoder is NOT compatible with 96kHz PCM, select "48kHz". 96kHz sound will be output in 48kHz.

**96kHz** : If your amplifier/decoder is compatible with 96kHz PCM, select "96kHz". 96kHz sound will be output.

#### Note

##### When playing back disc with copyright protection

- Even if you select "96kHz", the sound will be down sampled at 48kHz.

#### C Settings for Dolby Digital (Default : Stream)

Use [▲ / ▼] to select a setting, then press [ENTER].

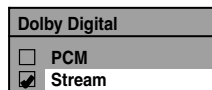

Your setting will be activated.

**PCM** : Converts the Dolby Digital into PCM (2 channel).  
When your amplifier/decoder is NOT compatible with Dolby Digital, set to "PCM".

**Stream** : Outputs Dolby Digital signals.  
When your amplifier/decoder is compatible with Dolby Digital, set to "Stream".

#### D Settings for DTS (Default : ON)

Select a setting using [▲ / ▼], then press [ENTER].

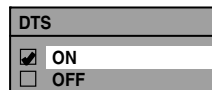

Your setting is activated.

**ON** : Outputs DTS signals.  
If your amplifier / decoder is compatible with DTS, set to "ON".

**OFF** : No DTS signal is output.  
If your amplifier / decoder is NOT compatible with DTS, set to "OFF".

## Playback (cont'd)

### 3 Disc Menu Language (Default : English)

Set the language for disc menu.

Use [▲ / ▼] to select a language, then press [ENTER].

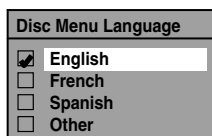

Your setting will be activated.

### 4 Audio Language (Default : Original)

Set the audio language.

Use [▲ / ▼] to select a language, then press [ENTER].

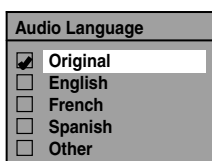

Your setting will be activated.

- When "Original" is selected, the audio language will be in the disc's default language.

### 5 Subtitle Language (Default : OFF)

Set the subtitle language.

Use [▲ / ▼] to select a language, then press [ENTER].

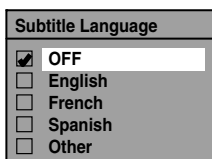

Your setting will be activated.

If "Other" is selected for **3** to **5**, press 4-digit code using [the Number buttons].

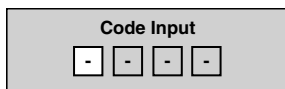

- When you finish entering the code, press [ENTER]. Refer to the language code table on page 107.

#### Note

- Only the languages supported by the disc can be selected.
- Audio language setting may not be available to some discs.
- You can also change or switch off the subtitles on a DVD from the disc menu if it is available.
- Press [CLEAR] to erase numbers entered incorrectly.

### 6 Angle Icon (Default : ON)

Set to "ON" to show the angle icon during the playback.

Use [▲ / ▼] to select a setting, then press [ENTER].

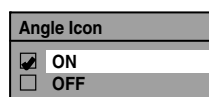

Your setting will be activated.

### 7 Still Mode (Default : Auto)

Select "Auto" usually.

Use [▲ / ▼] to select a setting, then press [ENTER].

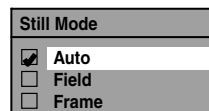

Your setting will be activated.

**Auto** : Optimum resolution setting ("Field" or "Frame") will be selected.

**Field** : Images in the still mode will be stabilized.

**Frame** : Images in the still mode will be highly defined.

#### Note

- Frame is one completed video image made up of two fields (There are 30 frames per second of NTSC video).

## Display

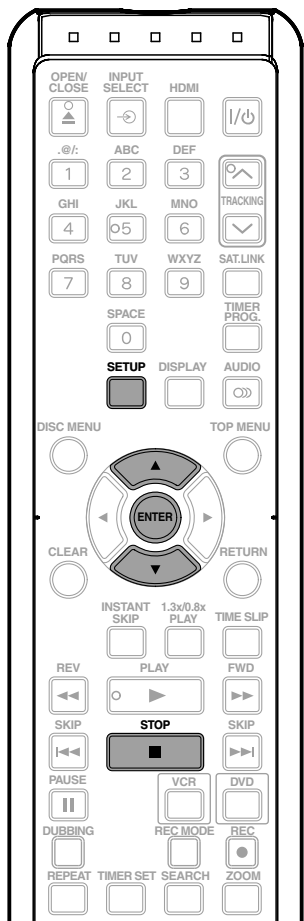

### 1 OSD Language (Default : English)

Set the language for the on-screen display.

Use **[▲ / ▼]** to select a language, then press **[ENTER]**.



Your setting will be activated.

### 2 Screen Saver (Default : 10 minutes)

Set the time to activate the screen saver function on the TV screen.

Use **[▲ / ▼]** to select a setting, then press **[ENTER]**.

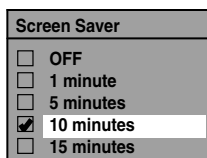

Your setting will be activated.

### 3 FL Dimmer (Default: Bright)

Set the front panel display brightness.

Use **[▲ / ▼]** to select a setting, then press **[ENTER]**.

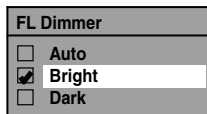

You can choose one from "Auto", "Bright" or "Dark".

If "Auto" is selected, the display gets dark when the power is off.

Press **[STOP ■]** if you are playing back a disc.

**1** Press **[SETUP]** and use **[▲ / ▼]** to select "General Setting", then press **[ENTER]**.

**2** Use **[▲ / ▼]** to select "Display", then press **[ENTER]**.

**3** Use **[▲ / ▼]** to select a desired item, then press **[ENTER]**.

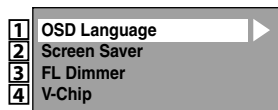

Submenu will appear.

**4** Press **[SETUP]** to exit.

## Display (cont'd)

### 4 V-Chip

With the V-chip system in this unit, you can set the viewing limitation for the analog TV programs received from the external tuner or recorded on DVDs to prevent your children from watching inappropriate programs. If the unit detects a blocked program, a restriction message appears and you are not allowed to view the program.

And be noted that the recorded contents on the cassette tape are not blocked. In such a case you can block them in the V-chip settings on your TV.

#### 1) Use [the Number buttons] to enter the access password.

If you have not set the password, first, use [the Number buttons] to set the access password, then press [ENTER]. The number you entered will be stored as the access password.

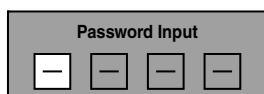

#### 2) Use [▲ / ▼] to select a desired item, then press [ENTER].

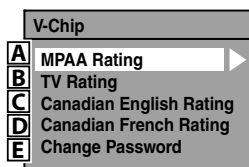

- A** MPAA Rating
- B** TV Rating
- C** Canadian English Rating
- D** Canadian French Rating

You can set the viewing limitation according to MPAA rating (US movie ratings), TV Rating (US TV program ratings), Canadian English Rating (Canadian English language ratings), Canadian French Rating (Canadian French language ratings).

#### 1) Use [▲ / ▼] to select the desired rating, then press [ENTER] repeatedly to switch between view and block. When it is blocked a key icon will appear.

e.g.) MPAA rating

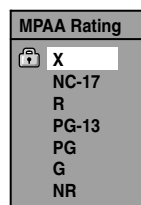

#### [MPAA Rating]

Rating	Category	
X	Mature audience only	higher ↑ ↓ lower
NC-17	No one under 17 admitted	
R	Restricted; under 17 requires accompanying parent or adult guardian	
PG-13	Unsuitable for children under 13	
PG	Parental guidance suggested	
G	General audience	
NR	No rating	

#### [TV Rating]

Rating	Category	
TV-MA	Mature audience only	higher ↑ ↓ lower
TV-14	Unsuitable for children under 14	
TV-PG	Parental guidance suggested	
TV-G	General audience	
TV-Y7	Appropriate for all children 7 and older	
TV-Y	Appropriate for all children	
None	No rating	

#### [Canadian English Rating]

Rating	Category	
18+	Adult audience only	higher ↑ ↓ lower
14+	Unsuitable for ages under 14	
PG	Parental guidance suggested	
G	General audience	
C8+	For children over 8	
C	For all children	
E	Exempt program	

# GENERAL SETTING

## Display (cont'd)

### [Canadian French Rating]

Rating	Category	
18ans+	Adult audience only	higher  lower
16ans+	Unsuitable for ages under 16	
13ans+	Unsuitable for ages under 13	
8ans+	Unsuitable for ages under 8	
G	General audience	
E	Exempt program	

As for TV Rating's TV-MA, TV-14, TV-PG, or TV-Y7, you can further set the sub ratings to block specific elements of programming. Press [**▲** / **▼** / **◀** / **▶**] to select the desired rating or sub rating, then press [**ENTER**] repeatedly to switch between view and block. Sub rating status will appear on the side of the main rating.

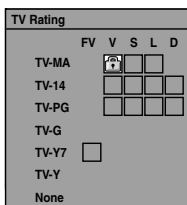

Sub Rating	Category	Rating
<b>FV</b>	Fantasy Violence	TV-Y7
<b>V</b>	Violence	TV-PG
<b>S</b>	Sexual Situation	TV-14
<b>L</b>	Coarse Language	TV-MA
<b>D</b>	Suggestive Dialogue	TV-PG, TV-14

### Note

- Changing the main rating to block or view automatically changes all its sub ratings to the same (block or view).

### E

#### Change Password

Change the current password.

Use [the Number Buttons] to enter new access password.

### Note

- Press [**CLEAR**] to erase numbers entered incorrectly.
- When you forgot the access password, enter 4737 using [the Number buttons] in password input window. Password will be cleared.

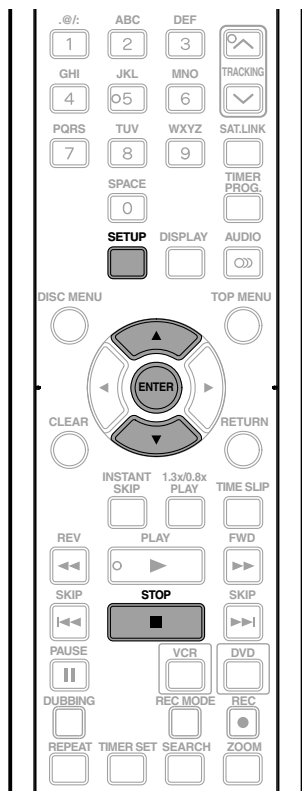

Press **[STOP ■]** if you are playing back a disc.

**1** Press **[SETUP]** and use **[▲ / ▼]** to select **"General Setting"**, then press **[ENTER]**.

**2** Use **[▲ / ▼]** to select **"Video"**, then press **[ENTER]**.

**3** Use **[▲ / ▼]** to select a desired item, then press **[ENTER]**.

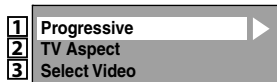

Submenu will appear.

**4** Refer **1** to **2** on this page and set the selected item.

- For **3**, refer to "SETTINGS FOR THE VIDEO INPUT" on page 27.

**5** When you finish with the setting, press **[SETUP]** to exit.

### 1 Progressive (Default : OFF)

This unit is compatible with the progressive scan system. The feature provides you with the higher definition images than the traditional output system does. To utilize this feature, you must set progressive scan mode to "ON".

**1) Use [▲ / ▼] to select "ON", then press [ENTER].**

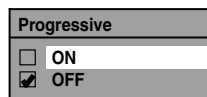

**2) Use [◀ / ▶] to select "Yes", then press [ENTER].**

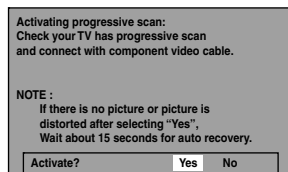

**3) Use [▲ / ▼] to select "Yes" within 15 seconds, then press [ENTER].**

Your setting will be activated.

#### Note

- If your TV is compatible with progressive scan (480p), you are recommended to use the HDMI or component video cable (commercially available) to connect this unit to the TV. (Refer to pages 20-21.) If not, use the RCA video cable and set the progressive scan to "OFF".
- If the Progressive Scan image is distorted, you can cancel Progressive Scan by pressing and holding **[SETUP]** for more than 3 seconds during DVD playback. The "Progressive" setting will be "OFF".
- When selecting "No" or not pressing any buttons on the unit or remote control within 15 seconds at step 3, progressive scan remains to be "OFF" (interlace scan).

### 2 TV Aspect (Default: 16:9 Wide)

You can select the TV aspect ratio to match the formats of what you are playing back with the unit and your TV screen (4:3 standard or 16:9 widescreen TV).

Use **[▲ / ▼]** to select a desired option, then press **[ENTER]**.

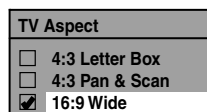

**If you have a standard TV:**

Select "4:3 Letter Box", so that black bars appear on the top and bottom of the TV screen when playing back a wide-screen picture. Select "4:3 Pan & Scan" for a full height picture with both sides trimmed when playing back wide-screen picture.

**If you have a widescreen TV:**

Select "16:9 Wide".

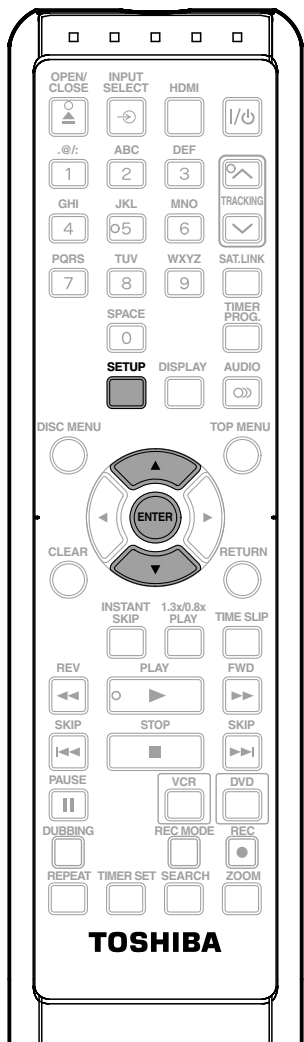

**3** Use [▲ / ▼] to select a desired item, then press [ENTER].

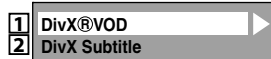

## 1 DivX® VOD

This unit allows you to play back the files purchased or rented from DivX® VOD (video-on-demand) services. The files are available on the internet. When you purchase or rent DivX® VOD files on the internet, you will be asked to enter an activation/registration code. This menu item provides you with the activation/registration code. On how to activate this unit for the DivX® VOD file playback, visit [www.divx.com/vod](http://www.divx.com/vod).



### Note

- One registration code is only valid for one DivX® VOD file.
- You must first download the file from the internet and play it back on this unit before you are able to get another code.
- You must follow this step every time you purchase or rent a DivX® VOD file from the internet.
- For more information for DivX®, please visit <http://www.divx.com/vod>.
- The registration code will be displayed in 8 characters consist of numbers between 0 to 9 and capital letters chosen randomly.

**1** Press [SETUP] in stop mode and use [▲ / ▼] to select "General Setting", then press [ENTER].

**2** Use [▲ / ▼] to select "DivX", then press [ENTER].

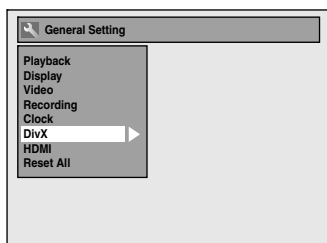

## 2 DivX Subtitle (Default : OFF)

Set the DivX® subtitle.

Use [▲ / ▼] to select a setting, then press [ENTER].

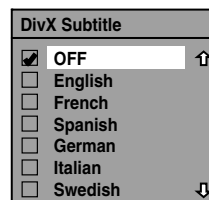

Your setting will be activated.

**4** When you finish with the setting, press [SETUP] to exit.



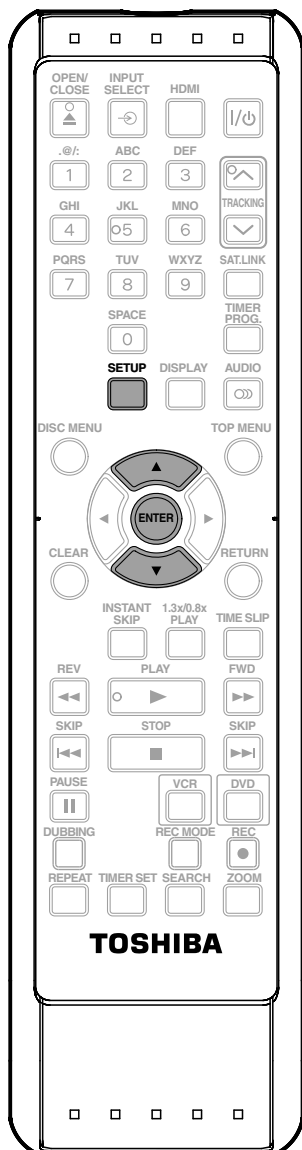

**1** Press [SETUP] in stop mode and use [▲ / ▼] to select "General Setting", then press [ENTER].

**2** Use [▲ / ▼] to select "HDMI", then press [ENTER].

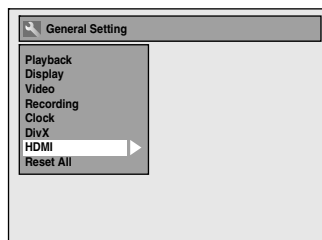

- You cannot select HDMI when an HDMI cable is not connected and the item is shown in grey color.

**3** Use [▲ / ▼] to select a desired item, then press [ENTER].

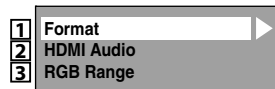

**4** When you finish with the setting, press [SETUP] to exit.

### 1 Format (Default : RGB)

You can select the color space for HDMI output. Set the appropriate color space for your display device.

**Use [▲ / ▼] to select a setting, then press [ENTER].**

- When the connected device is not compatible with the Y/Cb/Cr, HDMI signal is output as RGB regardless of the setting.

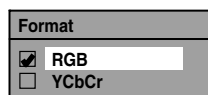

Your setting will be activated.

## HDMI (cont'd)

### 2 HDMI Audio (Default : ON)

If you do not want to output the audio through HDMI (when you digitally output the audio through the COAXIAL DIGITAL AUDIO OUT jack to your audio system, etc.), you can set the HDMI audio output off.

**Use [▲ / ▼] to select a setting, then press [ENTER].**

- Set to "OFF" when the HDMI sound is not output.

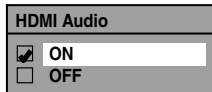

Your setting will be activated.

### 3 RGB Range (Default : Normal)

You can adjust the RGB range to make the dark areas of the HDMI images brighter.

**Use [▲ / ▼] to select a setting, then press [ENTER].**

- Select "Enhanced" if the black-white contrast is not clear.
- This setting is effective only for HDMI RGB output.

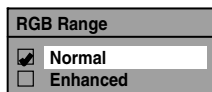

Your setting will be activated.

## Reset All

Reset the setting to default.

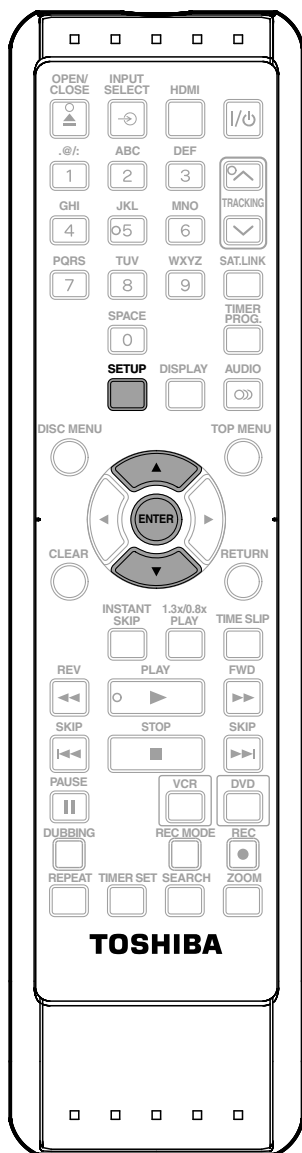

**1** Press [SETUP] in stop mode and use [▲ / ▼] to select "General Setting", then press [ENTER].

**2** Use [▲ / ▼] to select "Reset All", then press [ENTER].

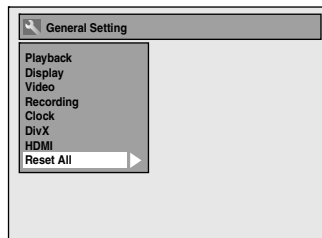

**3** Select "Yes" using [▲ / ▼], then press [ENTER].

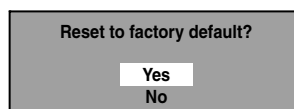

"Are you sure?" will appear. Select "Yes" using [▲ / ▼] and then press [ENTER]. Your setting will be initialized.

### Note

- The settings listed below will remain unchanged even after resetting to the factory default.
  - Clock setting
  - OSD language setting
  - Parental lock setting
  - DivX® VOD code
  - V-chip setting
  - Timer programs

# VCR FUNCTIONS

## Information on VCR Functions

### Caution on using S-video, component, or HDMI connection for VCR:

- Only the playback audio / video are available with these connections.
- Under the conditions listed below, the playback image and audio cannot be output. Use the standard video connection, in such case;
  - during DVD recording.
  - when L3 (DV-IN) is selected.
- HDMI video resolution cannot be changed when the unit is in VCR mode.

## Playback



### 1) Press [I/O ON/STANDBY] on the remote control or the front panel of the unit.

When you are playing back a cassette tape, turn on the TV and be sure to select the input to which the unit is connected.

Press [VCR].

### 2) Insert a prerecorded cassette tape. Press [PLAY ►] to begin playback.

### 3) During playback, press [PAUSE II].

Playback will pause and sound will be muted.

### 4) Press [PLAY ►] to resume playback.

### 5) Press [STOP ■] to stop playback.

### 6) Press [OPEN/CLOSE ▲] to eject the cassette tape.

### Note

- When a cassette tape ends during playback, fast-forward or normal recording, the unit will automatically rewind to the beginning of the cassette tape. After rewinding finishes, the unit will eject the cassette tape.
- When a cassette tape without erase-protection tab is inserted, the unit will start playback automatically.
- Tracking will be automatically adjusted upon playback. To adjust the tracking manually, press [TRACKING ▼ / ▲].
- Playback will stop when you change the output mode.

## Recording



### Press [VCR] first.

#### Before recording, make sure:

- The appropriate external input position (L1/L2) to which your external tuner is connected is selected by pressing [INPUT SELECT ○].
- There is a cassette tape with an erase-protection tab in the unit.
- The desired recording speed is selected in SP (standard playback) or SLP (super long playback) mode by pressing [REC MODE] repeatedly.

#### Recording speed:

Tape speed	Recording / playback time			
	Type of tape	T60	T120	T160
SP		1hour	2hours	2-2/3hours
SLP		3hours	6hours	8hours

- Refer to pages 39-42 for instructions on timer recording.

### 1) Press [REC ●] to begin the recording.

To temporarily stop recording or to resume it, press [PAUSE II]. After the unit has been in pause mode for 5 minutes, it will stop automatically to protect the cassette tape and the video head from damage.

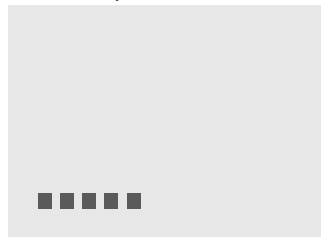

### 2) Press [STOP ■] when the recording is completed.

#### Accidental erasure prevention

To prevent accidental recording on a recorded cassette tape, remove its erase-protection tab. To record on it later, cover the hole with cellophane tape.

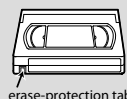

### Note

- This function is available only when the unit is connected by the VIDEO OUT jack.

## One-touch Timer Recording (OTR)



This feature allows you to set the recording length simply by pressing [REC ●] on the remote control.

**Press [VCR] first.**

**1) During normal recording, press [REC ●] to begin the one-touch timer recording.**

You can select a fixed recording time by pressing [REC ●] repeatedly.

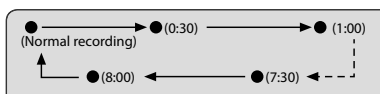

**When the one-touch timer recording is finished, the unit will turn off automatically.**

To change the recording length during the one-touch timer recording, press [REC ●] repeatedly until the desired length appear.

To cancel the one-touch timer recording within the specified time, press [STOP ■].

### Note

- The remaining recording time will be displayed on the front panel display during one-touch timer recording. Press [DISPLAY] to see it on the TV screen.
- **You cannot pause the one-touch timer recording.**
- If VCR the one-touch timer recording is completed during DVD playback or recording, the VCR will be in stop mode and the DVD keeps the current mode.
- Unlike a timer recording, you can perform the following operations during the one-touch timer recording.
  - Turning off the power (One-touch timer recording will be canceled.).
  - Using [REC ●] or [STOP ■].
- When the one-touch timer recording is finished and the power is turned off, the unit will switch to the standby mode automatically if a timer recording has been programmed. Press [TIMER SET] to cancel the standby mode for using the unit continuously.
- This function is available only when the unit is connected by the VIDEO OUT jack.

## Index Search



An index mark will be assigned at the beginning of each recording you make. You may skip to a specific marked point by following the steps below.

**Press [VCR] first.**

**1) Press [SEARCH] so that "INDEX SEARCH" menu appears.**

**2) Using [the Number buttons], enter the number of recordings you wish to skip within 30 seconds.**

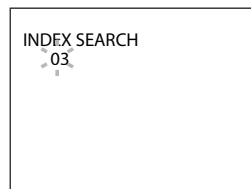

**3) Press [REV ◀◀], [FWD ▶▶] to start index search.**

If you want to go in the forward direction, press [FWD ▶▶].

If you want to go in the reverse direction, press [REV ◀◀].

After index search, the VCR will play back the cassette tape automatically.

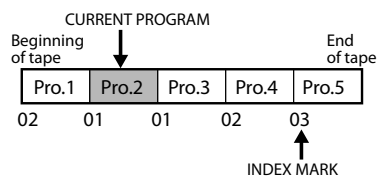

### Note

- You can make the index mark up to 20.
- This function is available only when the unit is connected by the VIDEO OUT jack.

# VCR FUNCTIONS

## Time Search



This feature allows you to go to a specific point on a cassette tape by entering the exact amount of time you wish to skip in order to reach the point.

### Press [VCR] first.

1) Press [SEARCH] repeatedly so that "TIME SEARCH" menu appears.

2) Using [the Number buttons], enter your desired time to skip within 30 seconds.

You can set the time up to 9:59.

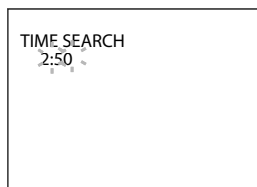

3) Press [REV ◀◀], [FWD ▶▶] to start time search.

If you want to go in the forward direction, press [FWD ▶▶].

If you want to go in the reverse direction, press [REV ◀◀].

After time search, the unit will play back the cassette tape automatically.

### Note

- Index search and time search are not available during recording.
- Press [STOP ■] to stop the search.
- If the end of the cassette tape is reached during search, this unit will cancel the search and rewind the cassette tape.
- This function is available only when the unit is connected by the VIDEO OUT jack.

## Other Operations



### Press [VCR] first.

#### Fast forward:

When the unit is in stop mode, press [FWD ▶▶] to fast forward the cassette tape.

#### Rewind:

When the unit is in stop mode, press [REV ◀◀] to rewind the cassette tape.

#### To cue or review picture during playback (picture search):

Press [REV ◀◀], [FWD ▶▶] during playback.

Press it again and the unit will search in super high speed. (in the SLP mode only)

#### To freeze the picture on TV screen during playback (still mode):

Press [PAUSE II]. Each time you press the button, the picture will be forwarded by one frame.

If the picture begins to vibrate vertically during the still mode, stabilize the picture by pressing [TRACKING ^ / v] on remote control.

If the picture is distorted or rolling vertically, adjust the vertical hold control on your TV, if equipped.

#### Counter reset:

Press [CLEAR] to reset the counter to "0:00:00".

#### To playback in slow motion:

Press [PAUSE II] during playback, then press [FWD ▶▶].

Press [FWD ▶▶] or [REV ◀◀] repeatedly during slow motion playback to select the desired speed.

#### Automatic rewind:

When a cassette tape is played back or fast forwarded to its end, the cassette tape will rewind to the beginning, stop and eject itself.

#### To repeat a playback indefinitely without touching [PLAY ▶] (Auto Repeat Playback):

During normal playback, press [REPEAT]. When a tape is played to its end, the tape will rewind to the beginning and start playback itself. To cancel the Auto Repeat Playback, press [REPEAT] again.

#### When you playback a cassette tape recorded in Hi-Fi stereo:

Press [AUDIO OD] on the remote control to select Hi-Fi or MONO for playback sound mode.

- If you have connected a stereo TV to this unit, select "HIFI".
- If you have connected a monaural TV to this unit, select "MONO".

Your Selection Type of recorded tape	HIFI		MONO
	L-channel	R-channel	
non Hi-Fi tapes	Monaural	Monaural	Monaural
Hi-Fi tapes recorded in Hi-Fi stereo	L	R	L+R
Hi-Fi tapes recorded main audio program	Main audio program	Main audio program	Main audio program
Hi-Fi tapes recorded second audio program	Second audio program	Second audio program	Second audio program

### Note

- Still/slow mode will stop after 5 minutes to prevent damage to the cassette tape and the video head.
- To return to playback from the picture search/still/slow mode, press [PLAY ▶].

# TROUBLESHOOTING

Before requesting service for this unit, check the table below for a possible cause of the problem you are experiencing. Some simple checks or a minor adjustment on your part may eliminate the problem and restore proper operation.

Symptom	Remedy
The power does not turn on.	<ul style="list-style-type: none"> <li>• Check that the AC power cord is connected securely.</li> <li>• Check the breaker (in case of power failure).</li> <li>• Press <b>[TIMER SET]</b> to cancel the timer standby mode.</li> </ul>
There is no picture.	<ul style="list-style-type: none"> <li>• Re-connect the connecting cords securely.</li> <li>• Check if the connecting cords are damaged.</li> <li>• Check the connection to your TV (page 19-22).</li> <li>• Check if the progressive scan mode is set correctly according to your TV (page 95).</li> <li>• Switch the input selector on your TV (such as to "L1") so that the signal from the unit appears on the TV screen.</li> </ul>
Cannot record a TV program.	<ul style="list-style-type: none"> <li>• This unit does not have a tuner to receive TV broadcasting.</li> <li>• You must connect this unit to an external tuner to record TV programs (page 19).</li> </ul>
TV program pictures are distorted.	<ul style="list-style-type: none"> <li>• Check if all the connections are made correctly (page 19).</li> </ul>
Playback picture is distorted.	<ul style="list-style-type: none"> <li>• Keep the device which may cause electrical disturbances, such as a cellular phone, away.</li> </ul>
Playback picture or TV program from the device connected through the unit is distorted.	<ul style="list-style-type: none"> <li>• If the playback picture output from a DVD player, VCR or tuner goes through the unit before reaching your TV, the copy-protection signal applied to some programs could affect picture quality. Disconnect the playback device in question and connect it directly to your TV.</li> </ul>
There is no sound.	<ul style="list-style-type: none"> <li>• Re-connect all connections securely.</li> <li>• Check if the connecting cord is damaged.</li> <li>• Check the connections to the amplifier input.</li> <li>• Check if the input device setting on the amplifier is correct.</li> <li>• When the unit is in pause mode or in slow-motion playback mode, sound is not output. This is not a malfunction.</li> <li>• When the unit is in fast forward or fast reverse mode, sound is not output. This is not a malfunction.</li> <li>• If the audio signal does not come through the DIGITAL AUDIO OUT (COAXIAL) jack, check the setting in "Audio Out" (page 90).</li> <li>• While the setup menu or timer programming display is shown, or while the screen saver is active, the audio is muted.</li> </ul>
No DTS sound on digital output.	<ul style="list-style-type: none"> <li>• Change the setting menu for "DTS" to "ON".</li> </ul>
No DTS sound from analog output	<ul style="list-style-type: none"> <li>• This unit has no analog sound output when playing back the selected DTS sound mode.</li> </ul>
Nothing was recorded even though you set the timer setting correctly.	<ul style="list-style-type: none"> <li>• There was a power failure during recording.</li> <li>• The unit's internal clock stopped due to a power failure that lasted for more than 30 seconds. Reset the clock (page 26).</li> <li>• The program contains copy protection signals that restricts copying.</li> <li>• The timer setting overlapped with another setting that has priority.</li> </ul>
Timer recording does not start.	<ul style="list-style-type: none"> <li>• No disc is inserted.</li> <li>• A disc is not recordable (finalized DVD-RW/-R, finalized DVD+R, a fully recorded disc, etc.).</li> </ul>
Timer recording is not complete or did not start from the beginning.	<ul style="list-style-type: none"> <li>• The timer setting overlapped with another setting that has priority (page 42).</li> <li>• Disc space was not enough.</li> <li>• "Make Recording Compatible" is not set to "ON", when recording onto DVD+RW/+R that was recorded on other unit.</li> </ul>
Timer recording is impossible.	<ul style="list-style-type: none"> <li>• Make sure  appears on the front panel display of this unit. If not, press <b>[TIMER SET]</b>.</li> </ul>
The remote control does not function.	<ul style="list-style-type: none"> <li>• Batteries are weak.</li> <li>• There are obstacles between the remote control and the unit.</li> <li>• The remote control is far from the unit.</li> <li>• There are no batteries in the remote control.</li> <li>• Check if the unit is turned on.</li> <li>• The remote control is not pointed at the infrared sensor window on the unit.</li> <li>• Press <b>[DVD]</b> or <b>[VCR]</b>, whichever you need. Then, try again.</li> <li>• Press <b>[TIMER SET]</b> to cancel the timer standby mode.</li> </ul>
The unit does not operate properly.	<ul style="list-style-type: none"> <li>• When static electricity, etc., causes the unit to operate abnormally, unplug the unit and then plug it in again.</li> </ul>

D  
V  
D  
·  
V  
C  
R

Introduction

Connections

Basic Setup

Disc Management

Recording

Playback

Editing

Function Setup

VCR Function

Others

# TROUBLESHOOTING

Symptom	Remedy
D V C R DV signal cannot be input.	<ul style="list-style-type: none"> <li>• Before connection, turn on the power supplies for both this unit and the DVC, and make sure that these units are in stop mode.</li> <li>• Only a "DVC-SD" signal can be input from the DVC to this unit. Other types of signals are not supported.</li> <li>• Do not connect any device other than the DVC. Even if a recorder or PC with another DV terminal is connected, the DV function will not operate.</li> <li>• If the DVC is not recognized after connection, turn off the power supply for the unit and re-connect the DVC.</li> </ul>
The DVC cannot be operated with this unit.	<ul style="list-style-type: none"> <li>• Signal input or DVC operation from this unit may be disabled depending on the type of DVC.</li> <li>• If a DVC signal cannot be input, use an external input (L1 (Rear)/L2 (front)) for analog connection via audio/video cables.</li> <li>• DVC control may be disabled depending on the type of DVC, even in a mode other than camera mode. In this case, switch to DVD control and execute the normal recording procedure while operating the DVC.</li> </ul>
D V C R Certain functions of the unit cannot operate.	<ul style="list-style-type: none"> <li>• Some functions may not operate depending on the type of DVC. For example, if the DVC does not support slow playback mode, the slow playback function is disabled.</li> <li>• With L3 (DV-IN), the disc display menu does not appear unless disc playback is executed.</li> </ul>
DV audio signal cannot be switched.	<ul style="list-style-type: none"> <li>• For recording with the DVC, the recording audio signal can be set to 12 bits or 16 bits. However, when 16-bit recording mode is selected, audio signal cannot be switched. To record an audio signal, set it to 12 bits.</li> </ul>
No image from HDMI connection.	<ul style="list-style-type: none"> <li>• Check the HDMI connection. (Check the status of the HDMI related indications.)</li> <li>• Check whether the connected monitor device or other device supports HDCP. (This unit will not output a video signal unless the other device supports HDCP.)</li> <li>• Check the setting of HDMI.</li> <li>• Check whether the output format of this unit (HDMI FORMAT) matches the supported input format of other connected device.</li> <li>• If the unit is connected to the unauthorized display device with an HDMI cable, the audio/video signal may not be output when playing back a commercial DVD-video.</li> </ul>
There is no picture.	<ul style="list-style-type: none"> <li>• If the setup menu appears on the TV screen, press <b>[RETURN]</b> to exit.</li> <li>• Check if the progressive scan mode is set correctly according to your TV (page 95).</li> </ul>
Picture noise appears.	<ul style="list-style-type: none"> <li>• Clean the disc with a cleaning cloth.</li> </ul>
Playback picture from the external devices connected to this unit is distorted.	<ul style="list-style-type: none"> <li>• If the picture output signal from the external devices passes through this unit to get to your TV, the copy protection signal applied to some DVD could affect the picture quality. Disconnect the playback device in question and connect it directly to your TV.</li> </ul>
There is no sound.	<ul style="list-style-type: none"> <li>• If you are using DIGITAL AUDIO OUTPUT (COAXIAL) jack, check the setting in "Audio Out" (page 90).</li> <li>• Clean the disc with a cleaning cloth.</li> </ul>
D V D Sound is noisy.	<ul style="list-style-type: none"> <li>• Clean the disc with a cleaning cloth.</li> </ul>
The disc does not play back.	<ul style="list-style-type: none"> <li>• No disc is inserted.</li> <li>• A blank disc is inserted.</li> <li>• The disc is upside down. Insert the disc with the labeled side facing up.</li> <li>• The disc is not correctly inserted.</li> <li>• The unit cannot play back certain discs (such as a CD-ROM) (page 10).</li> <li>• The region code on the DVD-video does not match the unit (page 10).</li> <li>• Moisture has condensed inside the unit. Remove the disc and leave the unit turned on for about 2 hours until the moisture evaporates (page 4).</li> <li>• If the disc was recorded on another recorder, the unit cannot play back the disc if it was not finalized.</li> </ul>
Playback image freezes for a second.	<ul style="list-style-type: none"> <li>• During the playback of 2 layered disc, picture may freeze for a moment when the 1st layer switches to the 2nd layer. This is not a malfunction.</li> </ul>
Discs recorded on this unit cannot be played back on other DVD players.	<ul style="list-style-type: none"> <li>• If you are using DVD-RW/-R or DVD+R, please ensure you finalized the disc after recording (pages 31-33).</li> </ul>

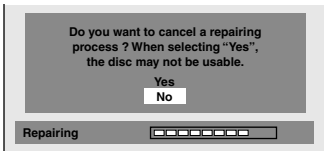

# TROUBLESHOOTING

	Symptom	Remedy
D V D	The disc does not start playback from the beginning.	<ul style="list-style-type: none"> <li>Resume playback was activated (page 59). Press <b>[STOP ■]</b> twice.</li> <li>You have inserted a disc whose title menu or DVD menu automatically appears on the TV screen when it is first inserted.</li> </ul>
	The unit starts playing back the disc automatically.	<ul style="list-style-type: none"> <li>The DVD-video features an auto playback function.</li> </ul>
	Some functions such as stop, search, or slow-motion playback cannot be performed.	<ul style="list-style-type: none"> <li>Depending on the disc, you may not be able to do some of the operations. Refer to the instruction manual supplied with the disc.</li> </ul>
	The language for the sound track cannot be changed.	<ul style="list-style-type: none"> <li>The title does not have the multilingual audio tracks.</li> <li>The DVD-video prohibits the changing of the language for the sound track.</li> </ul>
	The subtitle language cannot be changed or turned off.	<ul style="list-style-type: none"> <li>Multilingual subtitle are not recorded on the DVD-video.</li> </ul>
	The angles cannot be changed.	<ul style="list-style-type: none"> <li>Multi-angles are not recorded on the DVD-video being played back.</li> <li>The angle-change operation is whenever possible as long as the disc contains a multi-angle portion. Actual change will be performed when the portion has come up.</li> <li>The DVD-video prohibits changing angles.</li> <li>Try changing the angle using the DVD-video's menu.</li> </ul>
	Recording does not stop immediately after you press <b>[STOP ■]</b> .	<ul style="list-style-type: none"> <li>It may take a few seconds for the unit to input disc data before recording stops.</li> </ul>
	The disc tray does not open when you press <b>[OPEN/CLOSE ▲]</b> .	<ul style="list-style-type: none"> <li>It may take a few seconds for the disc tray to open after you have recorded or edited a disc. This is because the unit is adding disc data to the disc.</li> </ul>
	<p>"Repairing" appears on the TV screen.</p>  <p>In a case you intend to cancel the repairing process.</p> 	<ul style="list-style-type: none"> <li>If there is a power failure or unplugging during recording, finalizing, formatting or editing (even after "Repairing" disappears), a repairing process will begin automatically just after turning the unit on again. It may take several minutes up to about several hours.</li> <li>If you intend to cancel the repairing process, press <b>[▲ OPEN/CLOSE]</b> on the front panel, then select "Yes" and press <b>[ENTER]</b>. After that, press <b>[OPEN/CLOSE ▲]</b> to take out the disc. <b>The disc canceled during the repairing process MAY NOT work.</b></li> </ul>
	There is no sound or the sound is distorted.	<ul style="list-style-type: none"> <li>The HDMI sound is not output when "HDMI Audio" is set to "OFF".</li> <li>Check the RCA audio cable connection. If you are using HDMI-DVI conversion cable, you must connect the RCA audio cable, too.</li> <li>Check whether the output format of this unit (HDMI FORMAT) matches the supported input format of other connected device.</li> </ul>
Setup menu cannot be called up.	<ul style="list-style-type: none"> <li>Setup menus cannot be called up during DVD recording and playback.</li> </ul>	
V C R	There is no picture.	<ul style="list-style-type: none"> <li>If you connect the cable to S-VIDEO OUT/ COMPONENT VIDEO OUT / HDMI OUT jack, try connecting it to AUDIO / VIDEO OUT jack instead.</li> </ul>
	Picture noise appears.	<ul style="list-style-type: none"> <li>Head cleaning for VCR may be necessary. Refer to "Auto Head Cleaning" (page 5).</li> <li>Adjust tracking control for better picture by pressing <b>[TRACKING ^ / v]</b> while you are playing back a cassette tape.</li> </ul>
	The cassette tape does not play back.	<ul style="list-style-type: none"> <li>No cassette tape is inserted.</li> </ul>
	The tape ejected after you press <b>[REC ●]</b> .	<ul style="list-style-type: none"> <li>Make sure the cassette tape has an erase-protection tab when you record to a cassette tape. If needed, cover the hole with cellophane tape.</li> </ul>
	The remote control does not function.	<ul style="list-style-type: none"> <li>Check if a cassette tape is in this unit.</li> </ul>
The motor rotates even when playback / recording is stopped.	<ul style="list-style-type: none"> <li>The motor may rotate for the duration of approximately 5 minutes for efficient operation. This is not a malfunction.</li> </ul>	

# TROUBLESHOOTING

Error message	Cause	Solution
Disc Error — Please eject the disc. — Playback feature may not be available on this disc.	<ul style="list-style-type: none"> <li>Unplayable disc is inserted in the unit.</li> <li>The disc is upside down.</li> </ul>	<ul style="list-style-type: none"> <li>Insert the standardized disc which have the marks on pages 9-10.</li> <li>Insert the disc with the labeled side facing up.</li> </ul>
Region Error — Please eject the disc. — Playback is not authorized in your region.	<ul style="list-style-type: none"> <li>Playback is not authorized in the region of the DVD-video which you inserted in the unit.</li> </ul>	<ul style="list-style-type: none"> <li>Insert the DVD-video with region codes 1 or ALL.</li> </ul>
Parental Lock On The current selected parental level prohibits playback.	<ul style="list-style-type: none"> <li>The current selected parental level prohibits playback.</li> </ul>	<ul style="list-style-type: none"> <li>Check "Parental Lock" setting in "Playback" menu (page 89).</li> </ul>
Recording Error This program is not allowed to be recorded.	<ul style="list-style-type: none"> <li>You are trying to record the copy prohibited program.</li> </ul>	<ul style="list-style-type: none"> <li>You cannot record copy prohibited programs.</li> </ul>
Recording Error This program is not recordable in Video mode.	<ul style="list-style-type: none"> <li>You are trying to record the copy-once program onto the DVD-RW disc in Video mode.</li> </ul>	<ul style="list-style-type: none"> <li>Set "Format Mode" to "VR mode" (pages 28-29).</li> </ul>
Recording Error This program is not recordable in +VR mode.	<ul style="list-style-type: none"> <li>You are trying to record the copy-once program.</li> </ul>	<ul style="list-style-type: none"> <li>Insert the DVD-RW disc in VR mode (ver.1.1 or 1.2 compatible with CPRM).</li> </ul>
Recording Error Cannot record on this disc.	<ul style="list-style-type: none"> <li>You are trying to record onto the disc which is unrecordable, or the disc status is unable to record.</li> <li>The disc is dirty.</li> <li>The disc is damaged.</li> </ul>	<ul style="list-style-type: none"> <li>Insert the recordable disc, and ensure the disc status satisfies the recording requirements (page 9).</li> <li>Clean the disc with a cleaning cloth.</li> <li>Replace the disc.</li> </ul>
Recording Error This program is not allowed to be recorded on this disc.	<ul style="list-style-type: none"> <li>You are trying to record the copy-once program onto the DVD-RW disc which is not compatible with CPRM.</li> </ul>	<ul style="list-style-type: none"> <li>Insert the DVD-RW disc in VR mode (ver.1.1 or 1.2 compatible with CPRM).</li> </ul>
Recording Error This disc is protected and not recordable.	<ul style="list-style-type: none"> <li>You are trying to record onto the protected disc which is set in "DVD Menu" menu.</li> </ul>	<ul style="list-style-type: none"> <li>Release the disc protect setting in "DVD Menu" menu (page 30).</li> </ul>
Recording Error Disc is full. (No area for new recording)	<ul style="list-style-type: none"> <li>You are trying to record onto the disc which has no space for recording.</li> </ul>	<ul style="list-style-type: none"> <li>Insert the recordable disc with enough recording space.</li> </ul>
Recording Error You cannot record more than 99 titles on one disc. (The maximum is 99)	<ul style="list-style-type: none"> <li>You are trying to record onto the DVD-RW/-R on which the number of recording titles comes up to the maximum (99).</li> </ul>	<ul style="list-style-type: none"> <li>Delete unnecessary titles (pages 72-73).</li> </ul>
Recording Error You cannot record more than 999 chapters on one disc. (The maximum is 999)	<ul style="list-style-type: none"> <li>You are trying to record onto the VR mode DVD-RW on which the number of recording chapters comes up to the maximum (999).</li> </ul>	<ul style="list-style-type: none"> <li>Delete unnecessary chapter marks (page 78).</li> </ul>
Recording Error You cannot record more than 49 titles on one disc. (The maximum is 49)	<ul style="list-style-type: none"> <li>You are trying to record onto the DVD+RW/+R on which the number of recording titles comes up to the maximum (49).</li> </ul>	<ul style="list-style-type: none"> <li>Delete unnecessary titles (pages 72-73).</li> </ul>
Recording Error You cannot record more than 254 chapters on one disc. (The maximum is 254)	<ul style="list-style-type: none"> <li>You are trying to record onto the DVD+RW on which the number of recording chapters comes up to the maximum (254).</li> </ul>	<ul style="list-style-type: none"> <li>Delete unnecessary chapter marks (page 78).</li> </ul>
Recording Error You cannot record on this disc as Control Information is full.	<ul style="list-style-type: none"> <li>This disc has no space to write the Control Information when recording or deleting contents. When editing has been repeatedly performed, the control Information area may come up to be full even the recording area has enough space.</li> </ul>	<ul style="list-style-type: none"> <li>Delete unnecessary titles (pages 72-73).</li> </ul>
Recording Error You cannot record on this disc as Power Calibration Area is full.	<ul style="list-style-type: none"> <li>When recordings are performed repeatedly onto an unstable disc, this area may come up to be full.</li> <li>Every time you insert a disc for recording, the disc's working area will be taken up. And if you repeat this frequently, it will be used up sooner and you may not be able to record full 49 titles.</li> </ul>	<ul style="list-style-type: none"> <li>Insert a new disc.</li> </ul>
Recording Error This disc is already finalized.	<ul style="list-style-type: none"> <li>You are trying to record onto the disc already finalized.</li> </ul>	<ul style="list-style-type: none"> <li>Undo the finalizing for this disc (page 33).</li> </ul>
Recording Error The disc has no recording compatibility. Set "Make Recording Compatible" to "ON" to convert the disc.	<ul style="list-style-type: none"> <li>You are trying to record onto the unfinalized +VR mode discs recorded on other unit.</li> </ul>	<ul style="list-style-type: none"> <li>Set "Make Recording Compatible" to "ON" to rewrite the menu, after that you will record to disc (page 35).</li> </ul>

\* If you are still having trouble with the unit after checking "TROUBLESHOOTING", write down the error code and the error description for calling our help line to locate an Authorized Service Center.

## Frequently Asked Questions

- Can I record to CD-RW/-R?
- Can I play back DVD-video that is bought in another country?
- Can I connect the unit to my PC?
- Can I program a timer recording with cable/satellite box?

No, this unit records only DVD.  
Possible when the region code of the disc is 1 and All.  
No, you cannot control the unit by PC.  
Yes, you can. Select "L1(Rear)" or "L2(Front)" as your recording channel, and leave the cable/satellite box on (pages 19, 27 and 39-42).

# LANGUAGE CODE

Language	Code
Abkhazian	4748
Afar	4747
Afrikaans	4752
Albanian	6563
Amharic	4759
Arabic	4764
Armenian	5471
Assamese	4765
Aymara	4771
Azerbaijani	4772
Bashkir	4847
Basque	5167
Bengali; Bangla	4860
Bhutani	5072
Bihari	4854
Bislama	4855
Breton	4864
Bulgarian	4853
Burmese	5971
Byelorussian	4851
Cambodian	5759
Catalan	4947
Chinese	7254
Corsican	4961
Croatian	5464
Czech	4965
Danish	5047
Dutch	6058
English	5160
Esperanto	5161
Estonian	5166
Faroese	5261
Fiji	5256
Finnish	5255
French	5264
Frisian	5271
Galician	5358
Georgian	5747
German	5051
Greek	5158
Greenlandic	5758
Guarani	5360
Gujarati	5367
Hausa	5447
Hebrew	5569
Hindi	5455

Language	Code
Hungarian	5467
Icelandic	5565
Indonesian	5560
Interlingua	5547
Interlingue	5551
Inupiak	5557
Irish	5347
Italian	5566
Japanese	5647
Javanese	5669
Kannada	5760
Kashmiri	5765
Kazakh	5757
Kinyarwanda	6469
Kirghiz	5771
Kirundi	6460
Korean	5761
Kurdish	5767
Laothian	5861
Latin	5847
Latvian; Lettish	5868
Lingala	5860
Lithuanian	5866
Macedonian	5957
Malagasy	5953
Malay	5965
Malayalam	5958
Maltese	5966
Maori	5955
Marathi	5964
Moldavian	5961
Mongolian	5960
Nauru	6047
Nepali	6051
Norwegian	6061
Occitan	6149
Oriya	6164
Oromo (Afan)	6159
Panjabi	6247
Pashto; Pushto	6265
Persian	5247
Polish	6258
Portuguese	6266
Quechua	6367
Rhaeto-Romance	6459
Romanian	6461

Language	Code
Russian	6467
Samoa	6559
Sangho	6553
Sanskrit	6547
Scots Gaelic	5350
Serbian	6564
Serbo-Croatian	6554
Sesotho	6566
Setswana	6660
Shona	6560
Sindhi	6550
Singhalese	6555
Siswat	6565
Slovak	6557
Slovenian	6558
Somali	6561
Spanish	5165
Sundanese	6567
Swahili	6569
Swedish	6568
Tagalog	6658
Tajik	6653
Tamil	6647
Tatar	6666
Telugu	6651
Thai	6654
Tibetan	4861
Tigrinya	6655
Tonga	6661
Tsonga	6665
Turkish	6664
Turkmen	6657
Twi	6669
Ukrainian	6757
Urdu	6764
Uzbek	6772
Vietnamese	6855
Volapuk	6861
Welsh	4971
Wolof	6961
Xhosa	7054
Yiddish	5655
Yoruba	7161
Zulu	7267

Introduction

Connections

Basic Setup

Disc Management

Recording

Playback

Editing

Function Setup

VCR Function

Others

# GLOSSARY

## **Analog Audio**

An electrical signal that directly represents sound. Compare this to digital audio which can be an electrical signal, but is an indirect representation of sound. See also "Digital Audio".

## **Aspect Ratio**

The width of a TV screen relative to its height. Conventional TVs are 4:3 (in other words, the TV screen is almost square); widescreen models are 16:9 (the TV screen is almost twice as wide as it is high).

## **Chapter**

Just as a book is split up into several chapters, a title on a DVD is usually divided into chapters. See also "Title".

## **Component Video Output**

Each signal of luminance (Y) and component (P<sub>B</sub>/C<sub>B</sub>, P<sub>R</sub>/C<sub>R</sub>) is independent to output so that you can experience picture color as it is. Also, due to compatibility with progressive video (480p), you can experience higher-density picture than that in interlace (480i).

## **Digital Audio**

An indirect representation of sound by numbers. During recording, the sound is measured at discrete intervals (44,100 times a second for CD audio) by an analog-to-digital converter, generating a stream of numbers. On playback, a digital-to-analog converter generates an analog signal based on these numbers. See also "Sampling Frequency" and "Analog Audio".

## **DivX®**

DivX® is a codec (compression/decompression) that can compress images to a very small amount of data.

## **Dolby® Digital**

The system to compress digital sound developed by Dolby Laboratories. It offers you sound of stereo(2ch) or multi channel audio.

## **DTS® (Digital Theater System)**

DTS is a multi channel surround sound system. By connecting to DTS decoder you can enjoy dynamic and realistic sound like movie theatre. DTS surround sound technologies were developed by DTS, Inc.

## **Finalize**

To make DVD, which have been recorded on, possible to play back in DVD players.

## **HDMI (high definition multimedia interface)**

A digital interface between audio and video source. It can transmit component video, audio, and control signal with one cable connection.

## **JPEG (joint photographic experts group)**

JPEG is a method of compressing still image files. You can copy JPEG files on CD-RW/-R from a computer and play back the files on this unit.

## **MP3 (MPEG audio layer 3)**

MP3 is a method of compressing files. You can copy MP3 files on CD-RW/-R from the computer and play back the files on this unit.

## **PCM (pulse code modulation)**

The most common system of encoding digital audio, found on CD and DAT. Excellent quality, but requires a lot of data compared to formats such as Dolby Digital and MPEG audio. For compatibility with digital audio recorders (CD, MD and DAT) and AV amplifiers with digital inputs, this unit can convert Dolby Digital and MPEG audio to PCM. See also "Digital Audio".

## **Progressive Scan (480p)**

A type of display that does not split each frame into fields, and instead scans directly through all the scanlines of each frame in order. Progressive scan provides less flickering and higher image resolution than traditional (480i) TV signals. Refer to page 95 for instructions on selective progressive scan mode.

## **Region Code**

Regions associate discs and players with particular areas of the world. This unit will only play back discs that have compatible region codes. You can find the region code of your unit by looking on the rear panel. Some discs are compatible with more than one region (or all regions).

## **Sampling Frequency**

The rate which sound is measured by a specified interval to turn into digital audio data. The numbers of sampling in one second defines as sampling frequency. The higher the rate, the better the sound quality.

## **S-Video Output**

It delivers independently each signal of color(C) and luminance(Y) to TV as video signals, so that higher-quality picture will be gained.

## **Title (DVD only)**

A collection of chapters on DVD. See also "Chapter".

## **Track**

Audio CD use tracks to divide up the content of a disc. The DVD equivalent is called a chapter. See also "Chapter".

## **Video mode**

Video mode is the same recording format as used on the DVD videos you purchase in local shops. You can play back the discs recorded in this format in most DVD players, however it offers only limited editing. You will need to finalize discs recorded in video mode before playing them back on other unit.

## **VR mode**

A basic recording format for DVD-RW. VR mode offers advanced editing, however it is playable only on VR mode compatible unit. Finalization is recommended before playing them back on other unit.

## **WMA (Windows Media™ Audio)**

WMA is the audio compressing technology developed by Microsoft. You can copy WMA files on CD-RW/-R from a computer and play them back on this unit.

## **+VR mode**

A recording format for DVD+RW/+R. +VR mode offers basic editing, and it is playable on most DVD players. Finalization is recommended before playing them back on other unit.

# SPECIFICATIONS

- This model complies with the below specifications.
- Designs and specifications are subject to change without notice.
- This model may not be compatible with features and/or specifications that may be added in the future.

General	
VCR video heads	Four heads
Power requirements	AC120 V, 60 Hz
Power consumption	30 W (standby: 4.0 W)
Weight	9.5 lbs ( 4.3 kg )
Dimensions (width x height x depth)	17.13" x 3.92" x 10.87" (435 mm x 99.5 mm x 276 mm)
Operating temperature	41 °F to 104 °F (5 °C to 40 °C)
Operating humidity	Less than 80% (no condensation)
TV system	NTSC TV standard
Recording	
Recording format	VR (video recording) format Video format +VR format
Recording discs	DVD-Rewritable/-Recordable, DVD+Rewritable/+Recordable
Video recording format	
Sampling frequency	13.5 MHz
Compression format	MPEG
Audio recording format	
Sampling frequency	48 kHz
Compression format	Dolby Digital/LPCM (XP Recording mode only)
Input / Output	
Video input	
Input level	Input 1 (rear), 2 (front) 1 Vp-p (75Ω)
Jacks	RCA jack
Video output	
Output level	Output 1 (rear) 1 Vp-p (75Ω)
Jack	RCA jack
S-video input	
Y (luminance) - Input level	Input 1 (rear) 1 Vp-p (75Ω)
C (color) - Input level	286 mVp-p (75Ω)
Jacks	4 pin mini DIN
S-video output	
Y (luminance) - Output level	Output 1 (rear) 1 Vp-p (75Ω)
C (color) - Output level	286 mVp-p (75Ω)
Jack	4 pin mini DIN
Component video output	
Output level	Output 1 (rear) Y: 1.0 Vp-p (75Ω), Pb/Cb, Pr/Cr: 0.7 Vp-p (75Ω)
Jacks	RCA jacks
HDMI output	
Jack	HDMI jack
Audio input	
During audio input	Input 1 (rear), 2 (front) L/R 2 V rms (input impedance: more than 22 kΩ)
Jacks	RCA jacks
Audio output	
During audio output	Output 2 L/R (rear) 2 V rms (output impedance: less than 1 kΩ)
Jacks	RCA jacks
Digital audio output	
Output level	Output 1 (rear) COAXIAL 500 mVp-p (75Ω)
Jack	RCA jack
DV input	
Jack	IEEE 1394 DV input jack (4 pin)