

IMPORTANT SAFEGUARDS

■ **Read Instructions** — All the safety and operating instructions should be read before the appliance is operated.

■ **Retain Instructions** — The safety and operating instructions should be retained for future reference.

■ **Heed Warnings** — All warnings on the product and in the operating instructions should be adhered to.

■ **Follow Instructions** — All operating and use instructions should be followed.

■ **Cleaning** — Unplug this product from the wall outlet before cleaning. Do not use liquid cleaners or aerosol cleaners. Use a damp cloth for cleaning.

■ **Attachments** — Do not use attachments not recommended by the product manufacturer as they may cause hazards.

■ **Water and Moisture** — Do not use this product near water - for example, near a bath tub, wash bowl, kitchen sink, or laundry tub, in a wet basement, or near a swimming pool, and the like.

■ **Accessories** — Do not place this product on an unstable cart, stand, tripod, bracket, or table. The product may fall, causing serious injury to a child or adult, and serious damage to the product. Use only with a cart, stand, tripod, bracket, or table recommended by the manufacturer, or sold with the product. Any mounting of the product should follow the manufacturer's instructions, and should use a mounting accessory recommended by the manufacturer.

■ **Ventilation** — Slots and openings in the cabinet are provided for ventilation and to ensure reliable operation of the product and to protect it from overheating, and these openings must not be blocked or covered. The openings should never be blocked by placing the product on a bed, sofa, rug, or other similar surface. This product should not be placed in a built-in installation such as a bookcase or rack unless proper ventilation is provided or the manufacturer's instructions have been adhered to.

■ **Power Sources** — This product should be operated only from the type of power source indicated on the marking label. If you are not sure of the type of power supply to your home consult your appliance dealer or local power company. For products intended to operate from battery power, or other sources, refer to the operating instructions.

■ **Grounding or Polarization** — This product may be equipped with either a polarized 2-wire AC line plug (a plug having one blade wider than the other) or a 3-wire grounding type plug, a plug having a third (grounding) pin. The 2-wire polarized plug will fit into the power outlet only one way. This is a safety feature. If you are unable to insert the plug fully into the outlet, try reversing the plug. If the plug still fails to fit, contact your electrician to replace your obsolete outlet. Do not defeat the safety purpose of the polarized plug. The 3-wire grounding type plug will fit into a grounding type power outlet. This is a safety feature. If you are unable to insert the plug into the outlet, contact your electrician to replace your obsolete outlet. Do not defeat the safety purpose of the grounding type plug.

■ **Power-Cord Protection** — Power-supply cords should be routed so that they are not likely to be walked on or pinched by items placed upon or against them, paying particular attention to cords at plugs, convenience receptacles, and the point where they exit from the product.

■ **Lightning** — For added protection for this product during a lightning storm, or when it is left unattended and unused for long periods of time, unplug it from the wall outlet and disconnect the antenna or cable system. This will prevent damage to the product due to lightning and power-line surges.

■ **Overloading** — Do not overload wall outlets, extension cords, or integral convenience receptacles as this can result in a risk of fire or electric shock.

■ **A product and cart combination should be moved with care. Quick stops, excessive force, and uneven surfaces may cause the product and cart combination to overturn.**



■ **Object and Liquid Entry** — Never push objects of any kind into this product through openings as they may touch dangerous voltage points or short-out parts that could result in a fire or electric shock. Never spill liquid of any kind on the product.

■ **Servicing** — Do not attempt to service this product yourself as opening or removing covers may expose you to dangerous voltage or other hazards. Refer all servicing to qualified service personnel.

■ **Damage Requiring Service** — Unplug this product from the wall outlet and refer servicing to qualified service personnel under the following conditions:

- When the power-supply cord or plug is damaged.
- If liquid has been spilled, or objects have fallen into the product.
- If the product has been exposed to rain or water.
- If the product does not operate normally by following the operating instructions. Adjust only those controls that are covered by the operating instructions as an improper adjustment of other controls may result in damage and will often require extensive work by a qualified technician to restore the product to its normal operation.
- If the product has been dropped or damaged in any way.
- When the product exhibits a distinct change in performance - this indicates a need for service.

■ **Replacement Parts** — When replacement parts are required, be sure the service technician has used replacement parts specified by the manufacturer or have the same characteristics as the original part. Unauthorized substitutions may result in fire, electric shock or other hazards.

■ **Safety Check** — Upon completion of any service or repairs to this product, ask the service technician to perform safety checks to determine that the product is in proper operating condition.

■ **Heat** — The product should be situated away from heat sources such as radiators, heat registers, stoves, or other products (including amplifiers) that produce heat.

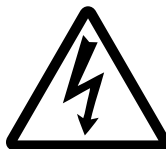
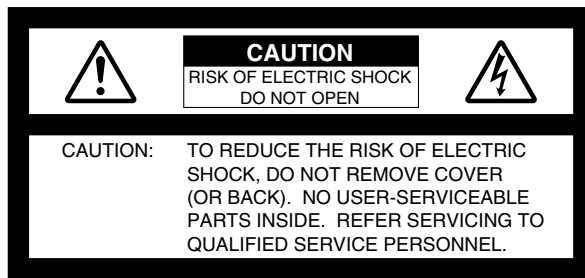

SA 1965

The lightning flash with arrowhead symbol, within an equilateral triangle, is intended to alert the user to the presence of uninsulated "dangerous voltage" within the product's enclosure that may be of sufficient magnitude to constitute a risk of electric shock to persons. This marking is located at the bottom of product.



SA 1966

The exclamation point within an equilateral triangle is intended to alert the user to the presence of important operating and maintenance (servicing) instructions in the literature accompanying the product.

WARNING:
TO REDUCE THE RISK OF FIRE OR ELECTRIC SHOCK, DO NOT EXPOSE THIS PRODUCT TO RAIN OR MOISTURE.

INFORMATION

This equipment has been tested and found to comply with the limits for a Class A digital device, pursuant to Part 15 of the FCC Rules. These limits are designed to provide reasonable protection against harmful interference when the equipment is operated in a commercial environment. This equipment generates, uses, and can radiate radio frequency energy and, if not installed and used in accordance with the instruction manual, may cause harmful interference to radio communications. Operation of this equipment in a residential area is likely to cause harmful interference in which case the user will be required to correct the interference at his own expense.

USER-INSTALLER CAUTION:

Your authority to operate this FCC verified equipment could be voided if you make changes or modifications not expressly approved by the party responsible for compliance to Part 15 of the FCC rules.

BEFORE YOU USE

- Use the Visual Presenter under the rated electrical conditions.
- Do not leave the Presenter under direct sunlight or by heaters, or the Presenter may be discolored, deformed, or damaged.
- Do not place the Presenter in any humid, dusty, windy or vibrating location. Use the Presenter in the following environmental conditions:
 - Temperature: 5°C~40°C (41°F~104°F)
 - Humidity: 30~85% (No condensation)
- Use a soft, dry cloth for cleaning. Do not use any volatile solvent, such as thinner or benzine.
- Do not directly point the camera lens into the sun, or the camera may be damaged.
- Caring for the batteries :
 - If the Presenter is not used for a long time, take out the batteries from the case.
 - Do not use rechargeable Ni-Cd batteries.
 - Do not use new and old batteries, or batteries of different types together.
 - Do not try to recharge or short-circuit the batteries.

CONTENTS

1. Part Names and Functions	6
Appearance	6
Front Operation Panel	7
Rear Panel	8
Wireless Remote Control	9
2. Wireless Remote Control	11
Preparation	11
3. Mouse	11
4. Setting Up	12
Connection to the monitor and the projector	13
Connection to the RGB-in terminal	
Connection to the composite video-in terminal	
Connection to the S-video-in terminal	
RGB input signal	14
Signal assignment	
Pin arrangement	
RGB output signal	14
Signal assignment (DSUB 15P shrinking terminal)	
Connection of analog RGB cable	
Restrictions on signal outputs (RGB composite video, S-video)	
Connecting the Desk-Top Presenter (HD-85XG)	16
5. Operation Procedures	17
Simple steps for presenting printed material	17
Simple steps for showing transparent material, such as overhead transparency or slide film	18
Storing the Presenter	19
6. Various Functions	20
Lighting	20
Input selection	20
Table of video-in/out terminal selections	
Resolution selection	21
Zoom	22
Focus	22
Auto Focus	
Powered Manual Focus	
Posi/Nega conversion	24
Color/B&W selection	24
Image rotation	24
Iris	25
Video pointer	25
Pause	25
Enlarging the image	26
LCD monitor bracket socket	26
About the PC software "Image Mate for USB"	26

7. OSD (On-Screen Display)	27
Main menu	28
Set menu	29
8. RS-232C Specifications	31
Setting up	31
Cable connection	31
RS-232C connector specifications (DSUB 9P)	31
Table of the communication commands	32
Data format specifications	33
Transmission command (PC→Visual Presenter)	
Response data format (Visual Presenter→PC)	
Transmission specifications	34
Connection	34
9. Troubleshooting Hints	35
10. Specifications	36
General	
Camera	
Lighting	
Supplied accessories	

1. PART NAMES AND FUNCTIONS

○ Appearance

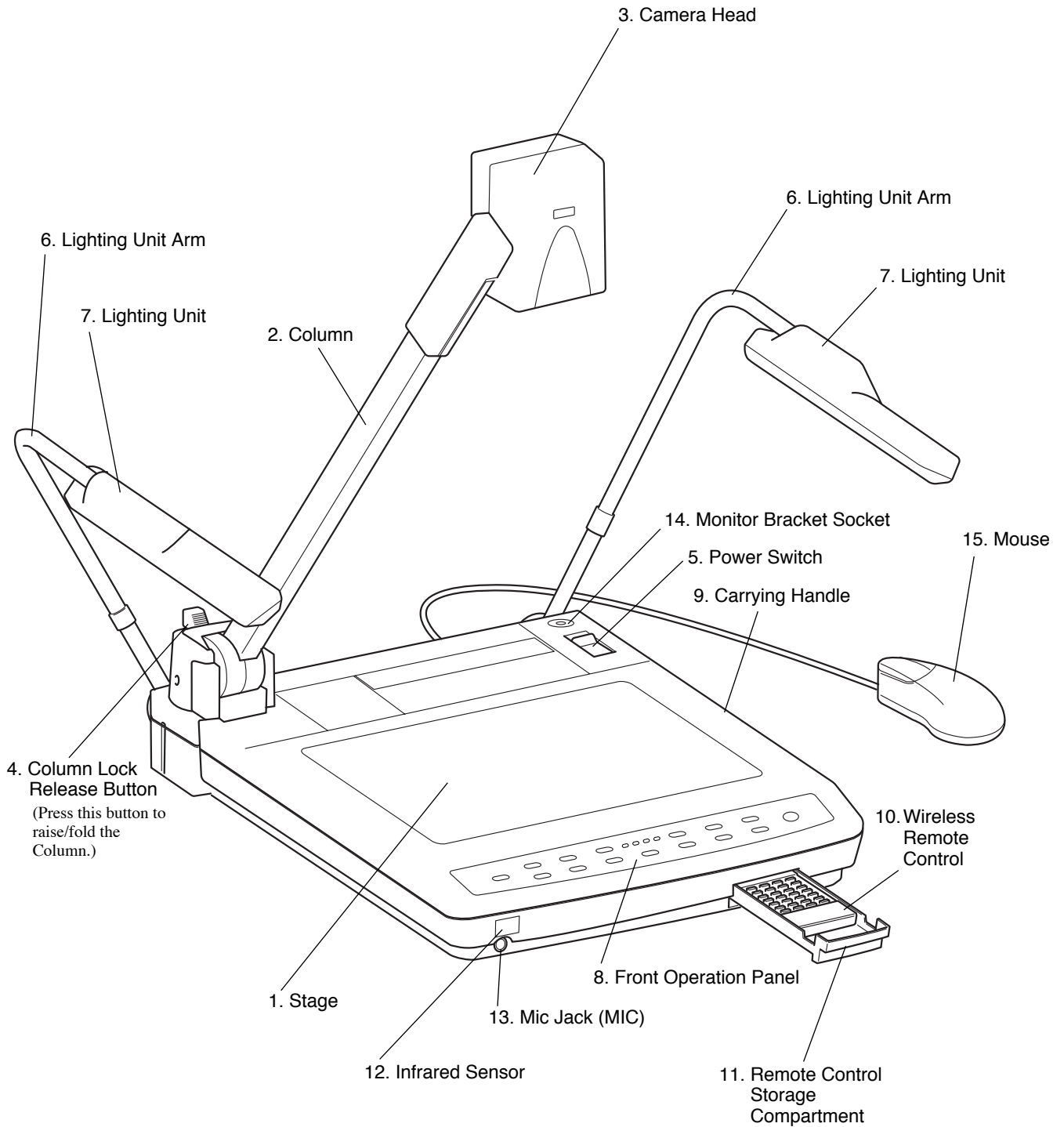

○ Front Operation Panel

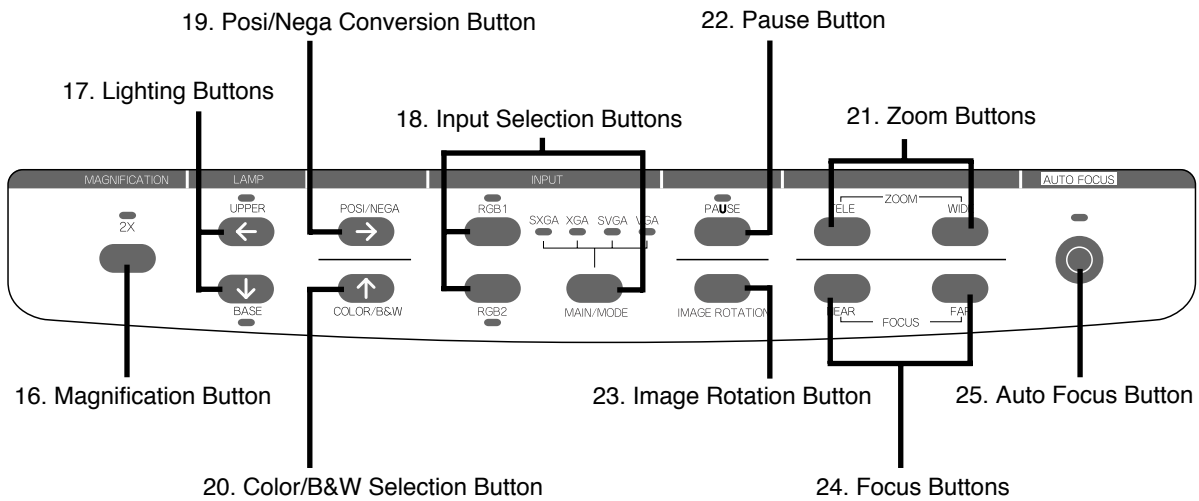

	Part Name	Function	Reference Page
16	Magnification Button	To electronically double the image size. The image is scrolled with the direction buttons.	P.26
17	Lighting Buttons [←], [→] (Direction Buttons)	To turn ON/OFF the lighting unit. When the image size is doubled, the image is scrolled in the arrow direction.	P.20
18	Input Selection Buttons Main/Mode Button	To change the input line. If the monitor is not compatible with SXGA, this mode can be switched in the order of SXGA → XGA → SVGA → VGA by changing the main body resolution.	P.20 P.21
19	Posi/Nega Conversion Button [→] (Direction Button)	To show negative films. When the image size is doubled, the image is scrolled in the arrow direction.	P.24
20	Color/B&W Selection Button [→] (Direction Button)	To present black-and-white material, such as documents. When the image size is doubled, the image is scrolled in the arrow direction.	P.24
21	Zoom Buttons	To change the image size.	P.22
22	Pause Button	To temporarily hold the image.	P.25
23	Image Rotation Button	To rotate the image. Each time this button is pressed, the image rotates counterclockwise by 90°.	P.24
24	Focus Buttons	To adjust focus (powered).	P.23
25	Auto Focus Button	To focus automatically. This is of one-shot auto focus system (FOCUSFREE)	P.22

○ Rear Panel

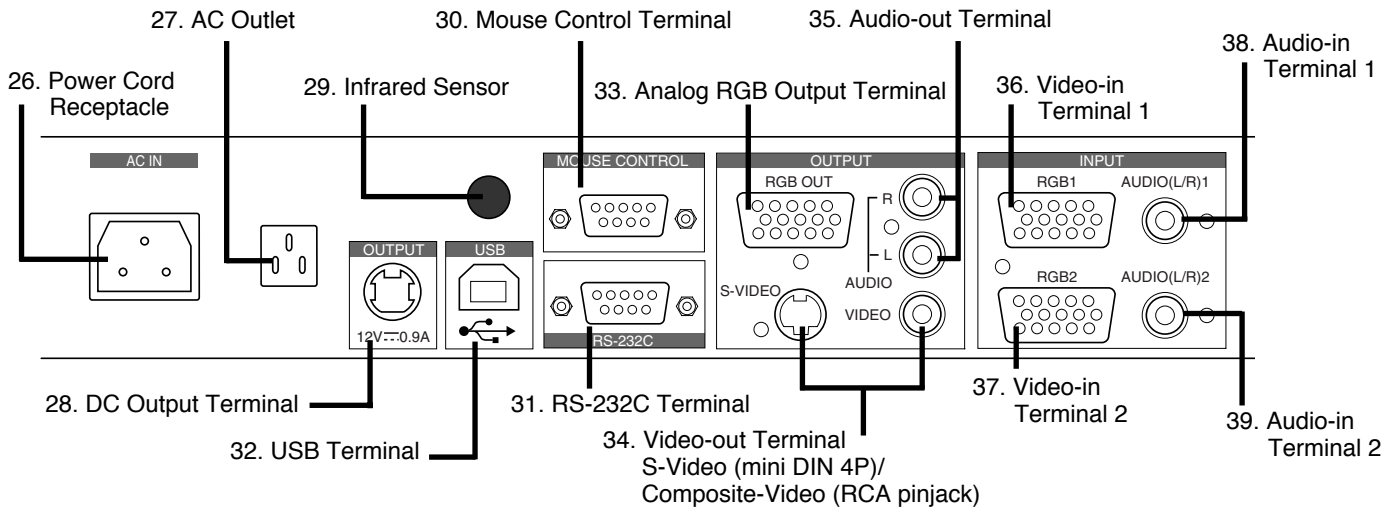

	Part Name	Function	Reference Page
26	Power Cord Receptacle [AC IN]	To connect the power cord.	
27	AC Outlet	To supply power up to 400W (Not interlocked with the power switch).	
28	DC Output Terminal [OUTPUT]	To output 12VDC. Any applicable equipment up to 0.9A can be connected. The optional LCD Color Monitor (LM-5011N) or ELMO Desk-top Presenter (HD-80XG) can be connected with the supplied DC cable. Note: Do not connect any equipment other than ELMO HD-80XG.	
29	Infrared Sensor	The light receiver of the wireless remote control. When operating the Presenter from behind, aim the wireless remote control at this light receiver.	P.11
30	Mouse Control Terminal [MOUSE CONTROL]	To connect the supplied mouse. Note: A serial type mouse is connected.	
31	RS-232C Terminal [RS-232C]	To connect a PC with an RS-232C cable to control the Presenter from the PC. Note: This terminal is disabled if the USB terminal is used for controlling the Presenter.	P.31
32	USB Terminal [USB]	To connect the supplied USB cable to control the image transfer and the Presenter by using the supplied CD-ROM [Image Mate for USB]. Note: This terminal is disabled if the RS-232C terminal is used for controlling the Presenter.	
33	Analog RGB Output Terminal [OUTPUT-RGB OUT]	To connect RGB input equipment, such as an LCD Projector and a Multi-SYNC Monitor, to output the image.	
34	Video-out Terminal [OUTPUT-S-VIDEO/VIDEO] S-Video (mini DIN 4P) Composite-Video (RCA pinjack)	To connect a NTSC/PAL conformable monitor, such as a TV monitor and the optional LCD Color Monitor (LM-5011N), to output the image.	
35	Audio-out Terminal [OUTPUT-AUDIO]	To connect audio input equipment to output the audio.	
36	Video-in Terminal 1 [INPUT-RGB1]	Video signal from this terminal is output through the analog RGB output terminal when input selection is set at RGB1.	
37	Video-in Terminal 2 [INPUT-RGB2]	Video signal from this terminal is output through the analog RGB output terminal when input selection is set at RGB2.	
38	Audio-in Terminal 1 [INPUT-AUDIO (L / R)1]	Audio signal from this terminal is output through the audio-out terminal when input selection is set at RGB1.	
39	Audio-in Terminal 2 [INPUT-AUDIO (L / R)2]	Audio signal from this terminal is output through the audio-out terminal when input selection is set at RGB2.	

○ **Wireless Remote Control**

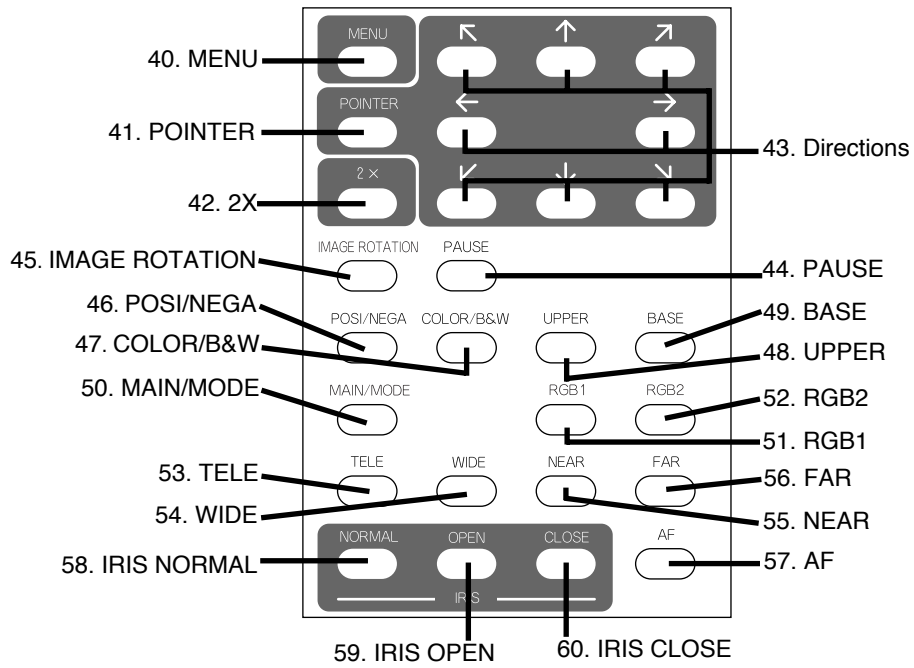

	Button Name	Function	Reference Page
40	MENU	To call the OSD (On-Screen Display) menu, and to fix the settings.	P.27
41	POINTER	To display the pointer on the screen.	P.25
42	2X	To electronically double the image size.	P.26
43	Directions	To move the video pointer displayed on the screen, to select the OSD item, and to scroll the screen in electronically enlarging an image or rotating an image (90°/270°).	P.25
44	PAUSE	To temporarily hold the image.	P.25
45	IMAGE ROTATION	To rotate the image. Each time this button is pressed, the image rotates counterclockwise by 90°.	P.24
46	POSI / NEGA	To select posi/nega modes.	P.24
47	COLOR / B&W	To select Color/B&W (Black&White) modes.	P.24
48	UPPER	To turn ON/OFF the upper lighting unit.	P.20
49	BASE	To turn ON/OFF the base lighting unit.	P.20
50	MAIN/MODE	To select the image from the built-in camera. If the monitor is not compatible with SXGA, this mode can be switched in the order of SXGA → XGA → SVGA → VGA by changing the main body resolution.	P.21
51	RGB1	To select the RGB1 image input.	P.20
52	RGB2	To select the RGB2 image input.	P.20
53	TELE	To zoom in.	P.22
54	WIDE	To zoom out.	P.22
55	NEAR	To move the focus near.	P.23
56	FAR	To move the focus far.	P.23
57	AF	To focus automatically.	P.22
58	IRIS NORMAL	To set the iris automatically.	P.25
59	IRIS OPEN	To open the iris manually.	P.25
60	IRIS CLOSE	To close the iris manually.	P.25

2. WIRELESS REMOTE CONTROL

Point the infrared emitting part of the wireless remote control unit at the infrared sensor of the Presenter, located at the front, and the rear panel, and press the button for the desired function.

The infrared sensor at the front can receive the infrared light if it comes from the wireless remote control within 7 meters at an angle of 30 degrees or less right and left. (5 degrees or less right and left for rear panel sensor.)

The sensitivity may be degraded when the Presenter is located under sunlight, or near inverter fluorescent lamps, or in any other unfavorable surroundings.

Depending on the conditions of fluorescent lamps, etc. the sensor may fail to receive the infrared light. In such a case, relocate the Presenter, or take other countermeasures.

○ Preparation

Remove the battery case cover by pressing downward on the [▼] mark part in the direction as indicated by the arrow. Install 2 pcs. of batteries (type R03, AAA) into the case in the direction as indicated there.

Notes: · Install the batteries with the right polarity.

- Change the batteries once a year.
- The batteries supplied with the Presenter are only for use in initially confirming the operation of the Presenter. It is not guaranteed that these batteries can work effectively for the indicated period.

3. MOUSE

Connect the mouse to the mouse control terminal on the rear panel.

The mouse can control the display and movement of the OSD and video pointer.

Reference Page

- OSD P.27
- Video pointer P.25

4. SETTING UP

- (1) Unfold the lighting unit arms fully until they come to the deadend. Unfold arm 1 and then arm 2 as illustrated.

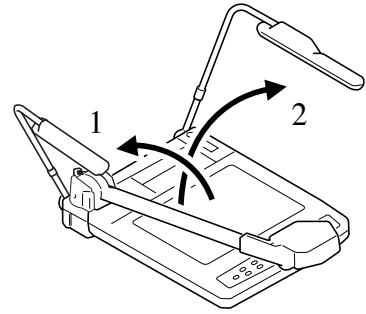

- (2) Press the column lock release button, and raise the column until the column lock release button returns to the original position. Make sure that the column has been locked properly.

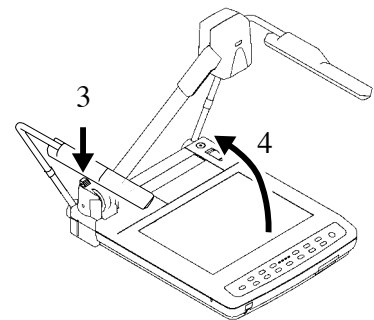

- (3) Plug the power cord into the power cord receptacle of the Presenter and the AC outlet.

○ Connection to the monitor and the projector

Note: Be sure to turn OFF the power supply to all equipment before making any connections to protect the Presenter and all the connected equipment.

Note: Hold the cable plug part when connecting or disconnecting the cables.

● Connection to the RGB-in terminal

Connect the RGB output terminal of the Presenter to the RGB input terminal of the equipment with the supplied RGB cable or a RGB connection cable available on the market.

If the display image shifts from the center, manually adjust the horizontal/vertical positions through the connected equipment.

If vertical stripes appear on the screen with the use of video projector, it may be improved by manually adjusting the dot-clock frequency of the projector.

Note: The resolution of the Presenter can be selected according to the resolution of the equipment to be connected.

Reference Page

• Resolution selection

P.21

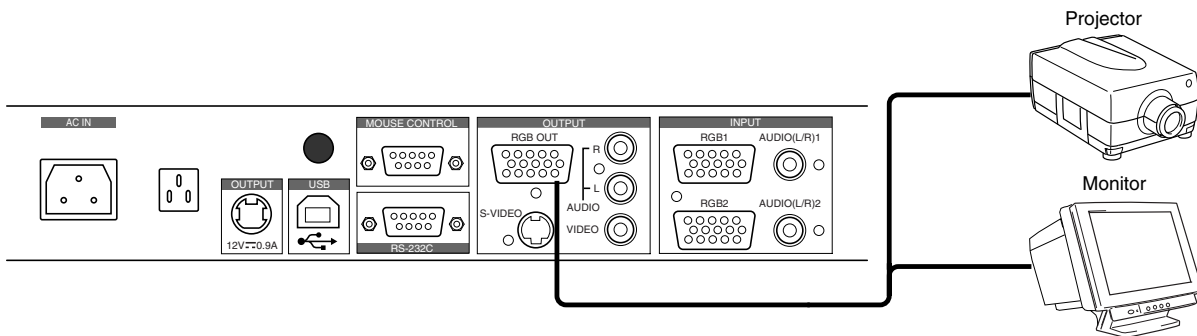

● Connection to the composite video-in terminal

Use the supplied RCA video/audio cable.

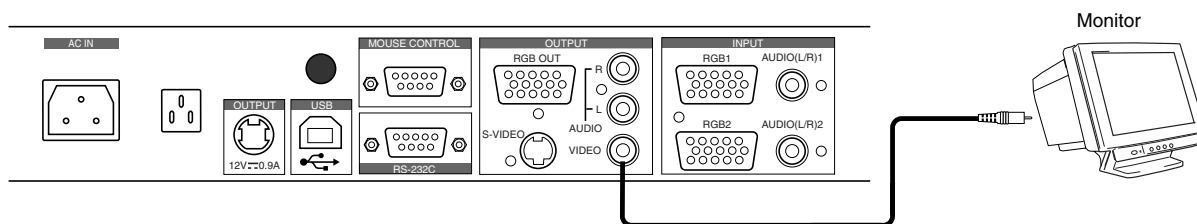

● Connection to the S-video-in terminal

Connect the S-video-out terminal (mini DIN 4P) of the Presenter to the S-video-in terminal of the monitor.

For the S-video mode, use the supplied 4P mini DIN cable or an S-video connection cable available on the market.

If the equipment to be used is provided with a Y/C separate connector, a conversion adapter is necessary.

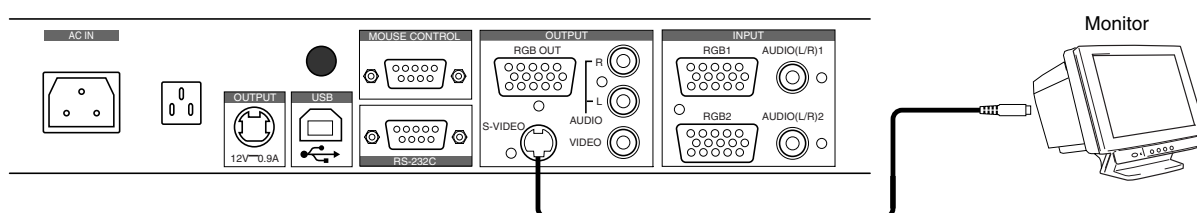

○ RGB input signal

● Signal assignment

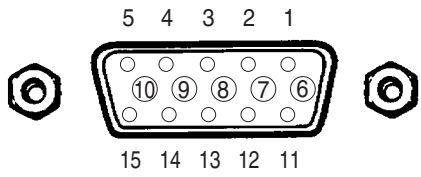

DSUB 15P shrinking terminal (Female)

Input signal

Video signal	Analog	0.7V(p-p)	75Ω
Horizontal synchronizing signal	TTL level	(positive / negative polarity)	
Vertical synchronizing signal	TTL level	(positive / negative polarity)	
Composite synchronizing signal	TTL level	(positive / negative polarity)	

● Pin arrangement

Pin No.	Name	Pin No.	Name	Pin No.	Name
1	Video input (Red)	6	GND (Red)	11	GND
2	Video input (Green)	7	GND (Green)	12	NC
3	Video input (Blue)	8	GND (Blue)	13	Horizontal synchronizing/ composite synchronizing signal
4	NC	9	NC	14	Vertical synchronizing signal
5	GND	10	GND	15	NC

○ RGB output signal

● Signal assignment (DSUB 15P shrinking terminal)

Pin No.	Name	Pin No.	Name	Pin No.	Name
1	Video output (Red)	6	GND (Red)	11	GND
2	Video output (Green)	7	GND (Green)	12	NC
3	Video output (Blue)	8	GND (Blue)	13	Horizontal synchronizing signal
4	NC	9	NC	14	Vertical synchronizing signal
5	GND	10	GND	15	NC

● Connection of analog RGB cable

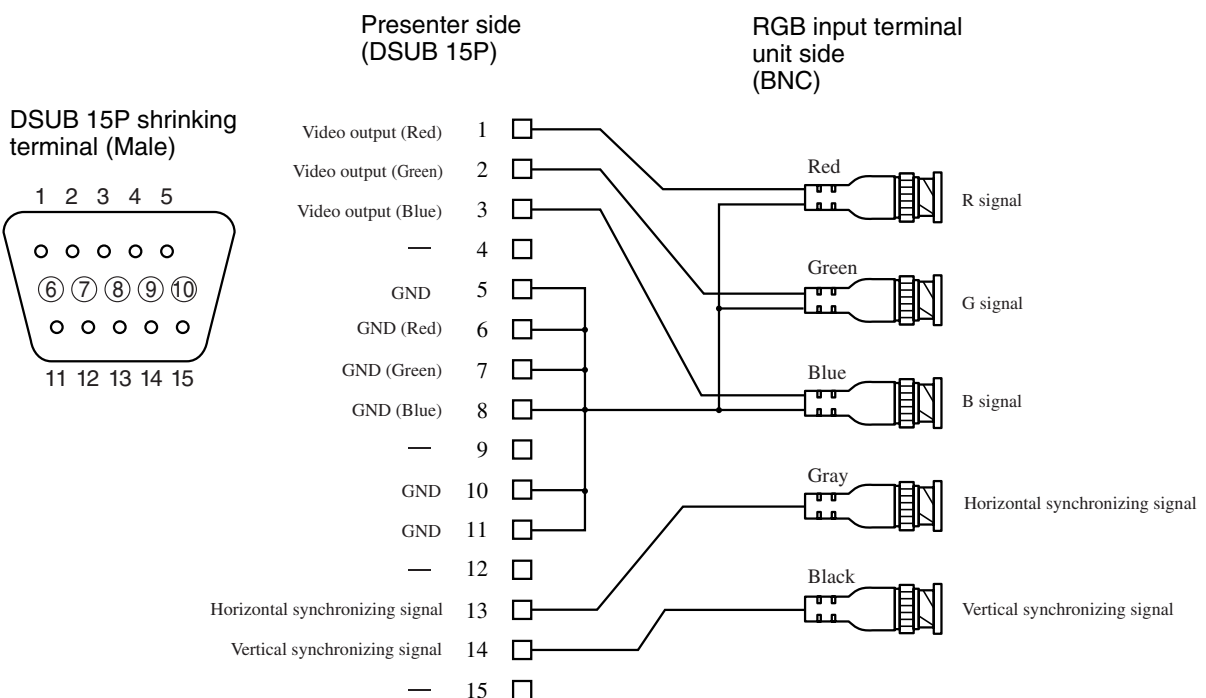

● **Restrictions on signal outputs (RGB, Composite video, S-video)**

Note: The specifications with "—" are not effective.

		Normal mode	Doubling	Pausing	B&W mode	Nega mode	Rotation mode
	Posi/Nega selection	○	※1	○	○	○	○
	Color/B&W selection	○		—	○	○	○
	2× Electric Zoom	○	○	○	○	○	○
	Resolution selection	○	○	※2	○	○	○
	Image rotation	○	○		○	○	○
SET MENU	White balance	○	○	—	—	※3	○
	Microphone volume	○	○	○	○	○	○
	Aperture selection	○	○	—	○	○	○
	Gamma selection	○	○	○	○	○	○

※1 In operating the buttons on the front operation panel, the scroll function is prioritized.

※2 Pausing is released.

※3 RED and BLUE inversely work in the manual mode.

○ Connecting the Desk-Top Presenter (HD-80XG)

Use the DC OUT socket of the unit to connect ELMO HD-80XG.

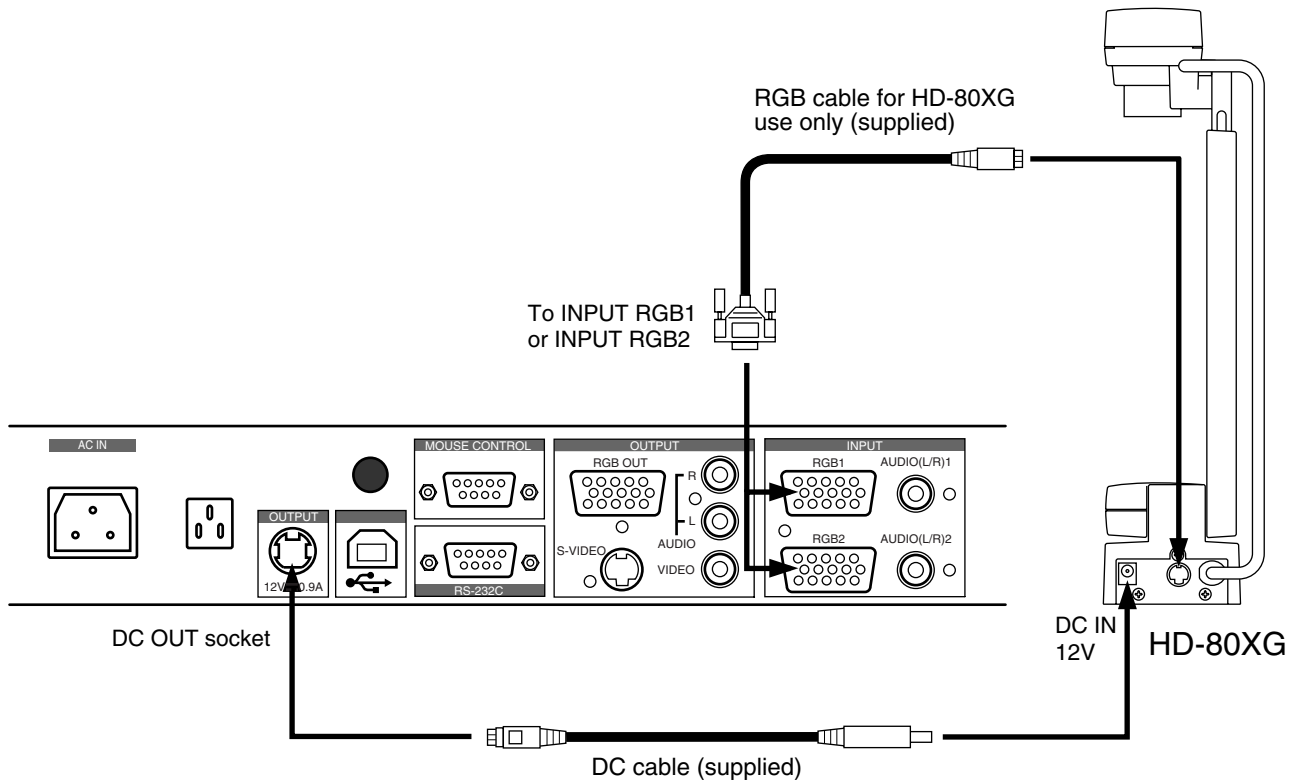

Note: When using the DC cable (supplied), AC adapter supplied with LM-5011N/HD-80XG is not used.

5. OPERATION PROCEDURES

○ Simple steps for presenting printed material

(1) Turn ON the power switch.

Notes: · Before turning ON the power switch, connection to the monitor should have been completed.

· The indication lamp (green LED) on the front operation panel shows the initial setting condition of each function of the Presenter.

After the power switch is turned ON, the indication lamp of the main camera only is illuminated.

· If the power switch is turned ON immediately after being turned OFF, the Presenter may not operate. For restarting, turn ON the power switch several seconds after turning OFF.

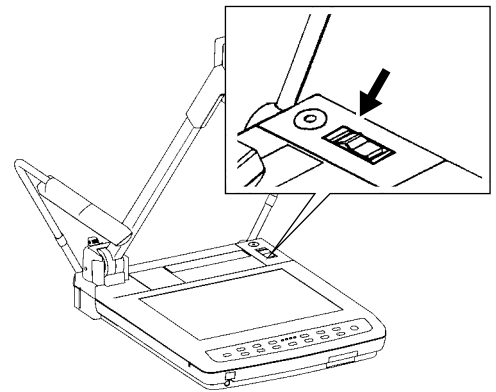

(2) Place the object on the stage. Adjust the image size according to the object size using the zoom buttons **[TELE]** and **[WIDE]** on the operation panel or wireless remote control, while watching the image on the monitor.

Front operation panel

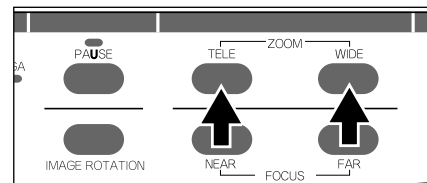

Wireless remote control

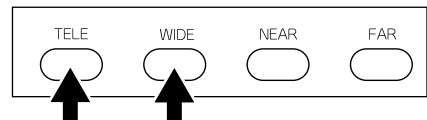

(3) Press the auto focus button **[AF]** on the front operation panel or remote control for focusing.

Note: The auto focus function works up to a height of approx. 10 cm above the stage surface.

Front operation panel

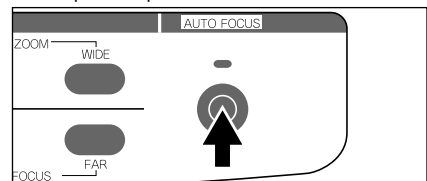

Wireless remote control

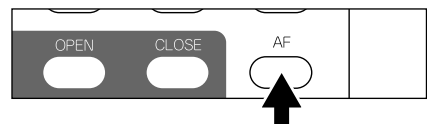

○ Simple steps for showing transparent material, such as overhead transparency or slide film

- (1) Press the base button **[BASE]** on the front operation panel or wireless remote control. The indicator of the base button **[BASE]** will blink, and the built-in baselight will light up.

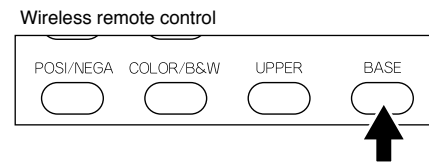
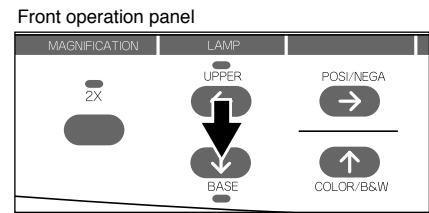

- (2) To present a nega film, press the posi/nega conversion button **[POSI/NEGA]** on the front operation panel or wireless remote control to change the mode to nega.

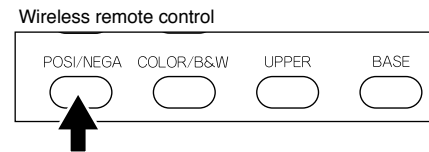
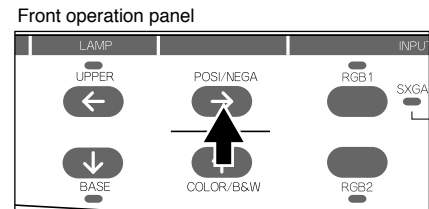

- (3) To turn OFF the baselight, press the base button **[BASE]** on the front operation panel or wireless remote control.

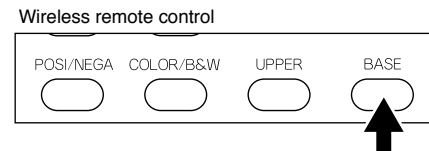
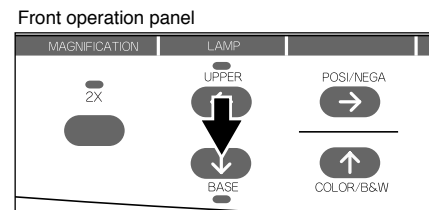

○ Storing the Presenter

Note: The Presenter can not be stored with the LCD monitor (optional) attached. Before storing, detach the LCD monitor (optional) and monitor bracket (optional), if connected.

(1) Turn OFF the power switch, and unplug the power cord and the video cable.

(2) Press the column lock release button, and fold down the main column.

Note: The illustration shows the storage position of the column. Never apply excessive force to the column.

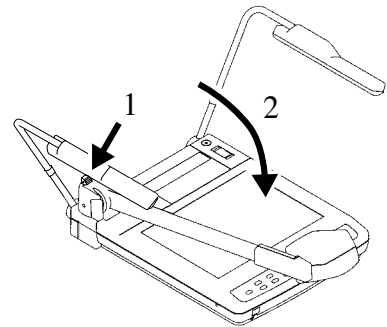

(3) Fold down the lighting unit arms 3 and 4. Be sure to fold down arm 3 first as per the illustration.

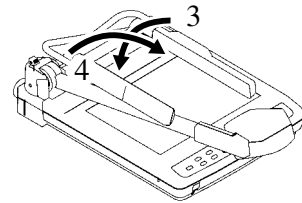

6. VARIOUS FUNCTIONS

○ Lighting

The upper lighting unit for presenting material such as printed matter and 3-D object, and the baselight for presenting transparent material, such as slide, and negative film, are built in the Presenter.

Depending on the material to be presented, press the button **[UPPER]** or **[BASE]** on the front operation panel or wireless remote control. The indication lamp will blink for a few seconds, and then the fluorescent lamp will light up.

To turn OFF the lamp, press the button for the respective lamp.

It has been so set before shipment that the lighting unit lights up when the power supply is turned ON.

Notes: · It is impossible to have the upper lighting unit and the baselight lit up together.

- When the lightness of the material surface is not sufficiently high or a 3-D object is presented, a sharp image with good color rendering can be obtained with the upper lighting unit.
- To reduce glare, attach enclosed stickers, as shown, to the outside ends, of toplights.

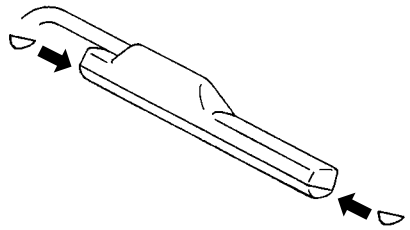
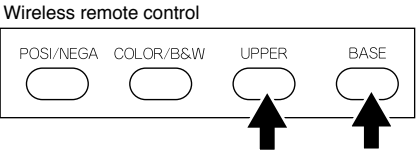
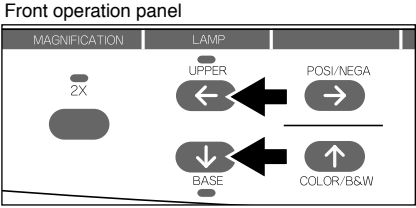

○ Input selection

The respective images from two different AV sources, such as PC and ELMO Presenters [HD-80XG], can be alternately presented on the Monitor by simply selecting the AV source by pressing the input selection button without changing cable connections.

Press the input selection button **[RGB1]** / **[RGB2]** on the front operation panel or wireless remote control.

When the input is selected, the signal is outputted as shown in the following page.

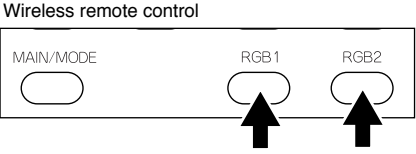
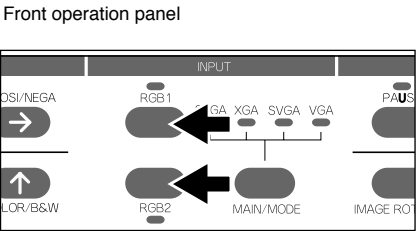

● **Table of video-in/out terminal selections**

Input		Output signal		Video-out terminal			Audio-out terminal	
				RGB	Composite	S-VIDEO	L	R
INTER- NAL	Main camera video signal		○	○	○	—	—	
	Mic.	Monaural	—	—	—	○	○	
R G B 1	Main cameravideo signal		—	○	○	—	—	
	Ext. video signal1	RGB1	○	—	—	—	—	
	Ext. audio signal1	Stereo1 (L / R)	—	—	—	○	○	
	Mic.	Monaural	—	—	—	○	○	
R G B 2	Main cameravideo signal		—	○	○	—	—	
	Ext. video signal2	RGB2	○	—	—	—	—	
	Ext. audio signal2	Stereo2 (L / R)	—	—	—	○	○	
	Mic.	Monaural	—	—	—	○	○	

Note: The Composite-Video Terminal and the S-Video Terminal receive the image from the main camera regardless of the input selection.

○ **Resolution selection**

When the built-in camera/mode button **[MAIN/MODE]** on the front operation panel or wireless remote control is pressed, the resolution of the built-in camera is switched.

If the monitor is not compatible with SXGA, the resolution of the built-in camera is switched to other in the order of SXGA → XGA → SVGA → VGA each time the built-in camera/mode button **[MAIN/MODE]** is pressed.

Then, the LED of the selected resolution of all 4 LEDs on the built-in camera/mode button **[MAIN/MODE]** on the front operation panel lights up to indicate the selected resolution.

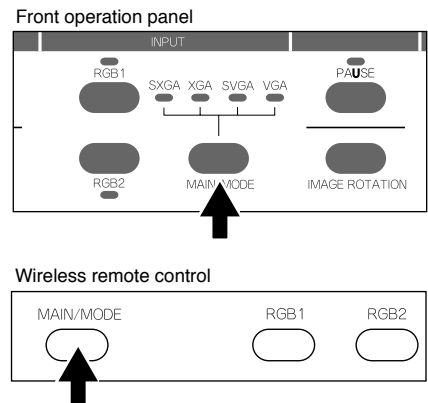

○ Zoom

Press the zoom button **[TELE]** on the front operation panel or wireless remote control, and the image will gradually be enlarged.

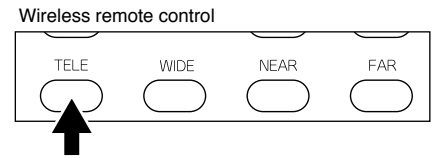
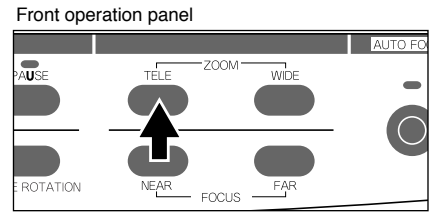

Press the zoom button **[WIDE]** on the front operation panel or wireless remote control, and the image will be gradually reduced.

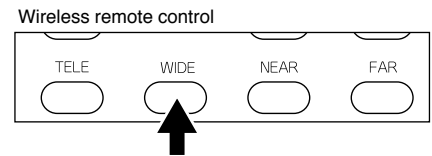
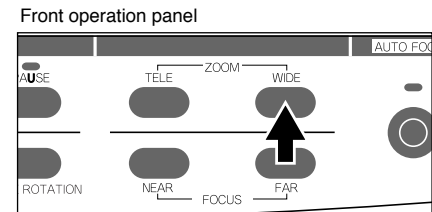

○ Focus

● Auto Focus

To operate Auto-Focus, press the auto focus button **[AF]** on the front operation panel or wireless remote control, and the Auto-Focus will be activated.

While the auto-focus is in operation, the indication lamp blinks until the object is brought into focus.

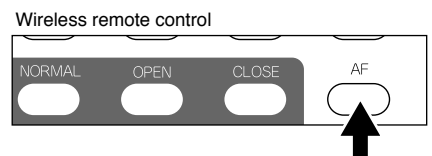
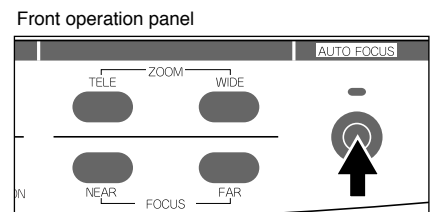

The Presenter features a one-push auto focus function. Once focusing is completed, the auto focus function is released, and the focused position maintains unchanged. (FOCUSFREE)
To obtain sharper image, zoom in on the object in the auto-focus mode while pressing the zoom button **[TELE]** on the front operation panel or wireless remote control.

However, the objects listed below may not be brought into focus in the auto focus mode. In these cases, use the manual focus mode.

- Objects bearing little contrast
- Objects with fine repeated patterns, such as lateral stripes and cross stripes
- Objects glittering or reflecting strong light
- Objects with bright background, or excessive contrast
- Objects in a dark picture plane
- Objects located near and far away at the same time
- Objects in motion

If the focus button **[NEAR]** or **[FAR]** on the front operation panel or wireless remote control is pressed during the auto focus, the auto focus will be released.

Notes: · The auto focus functions up to approx. 10cm above the stage surface.

- If the camera head gets heavy shock by accident, there is a possibility of out of focus. In such a case, once turn the power OFF and then re-set to ON.
- It may take some time to bring the camera into focus in the auto focus mode. Roughly bring the camera into focus manually and then press the auto focus button **[AF]**.

● Powered Manual Focus

To focus on any part of the material, such as 3-D material, press the focus button **[NEAR]** or **[FAR]** on the front operation panel or wireless remote control.

Note: The manual focus works up to approx. 10cm above the stage surface.

Front operation panel

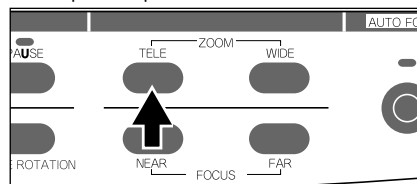

Wireless remote control

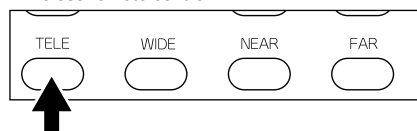

Front operation panel

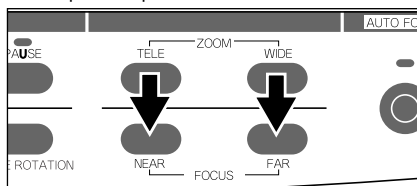

Wireless remote control

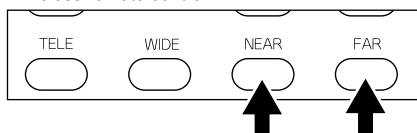

Front operation panel

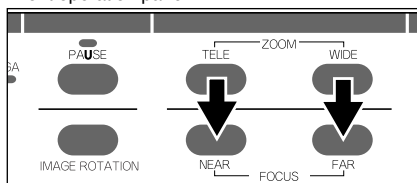

Wireless remote control

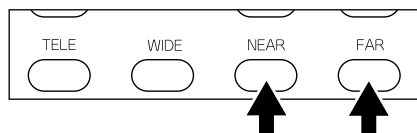

○ Posi/Nega conversion

To show a negative film.

Press the posi/nega conversion button **[POSI / NEGA]** on the front operation panel or wireless remote control, and the image will be converted accordingly.

To return to the normal (POSI) mode, press the posi/nega conversion button **[POSI / NEGA]** again.

Front operation panel

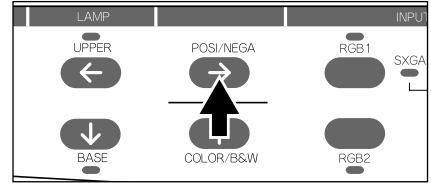

Wireless remote control

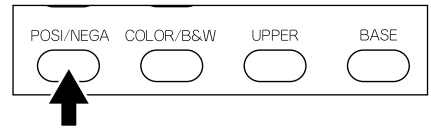

○ Color/B&W selection

To present the B&W (Black&White) material such as documents in sharper image with no color blur on the monitor, set to color mode for normal use.

To change to B&W mode, press the color/B&W selection button **[COLOR / B&W]** on the front operation panel or wireless remote control.

To return to normal (COLOR) mode, press the color/B&W selection button **[COLOR / B&W]** again.

Front operation panel

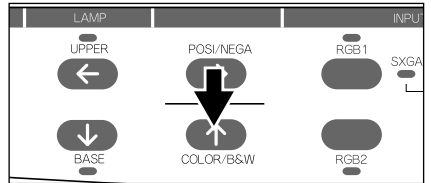

Wireless remote control

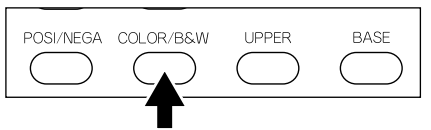

○ Image rotation

When the image rotation button **[IMAGE ROTATION]** on the Front Operation Panel or Wireless Remote Control is pressed, the image rotates.

Each time the image rotation button **[IMAGE ROTATION]** is pressed, the image rotates counterclockwise by 90°.

When the image is rotated by 90° or 270°, the screen can be scrolled in the up/down direction. For further information, refer to "Video pointer" on P.25.

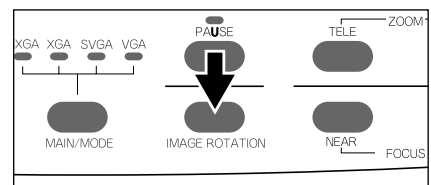

Wireless remote control

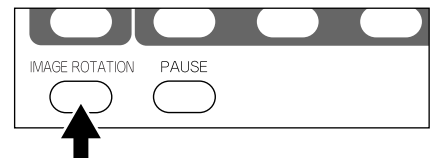

Mouse

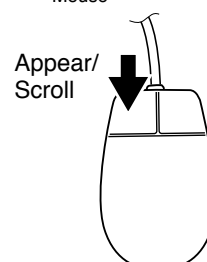

○ Iris

The iris can be manually adjusted.

To open the iris, press the manual iris button **[OPEN]**.

To close the iris, press the manual iris button **[CLOSE]**.

In the manual mode, the iris is fixed regardless of the change in lightness of object.

The initial setting is "auto iris."

Note: For the information of adjusting by means of the OSD, see P.29 .

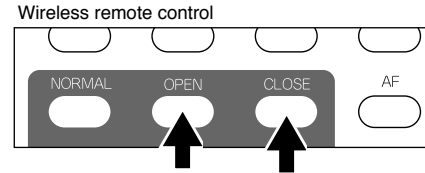

○ Video pointer

When the pointer button **[POINTER]** on the wireless remote control is pressed or the left button of the mouse is clicked, the video pointer appears.

The video pointer is moved by using the direction buttons on the wireless remote control or front operation panel of the Presenter or by clicking and dragging the left button of the mouse.

When the pointer button **[POINTER]** on the wireless remote control is pressed or the left button of the mouse is clicked, the video pointer disappears.

Note: The video pointer is switched to the moving pointer when the image is electronically magnified or rotated (90° / 270°) and the screen is scrolled.

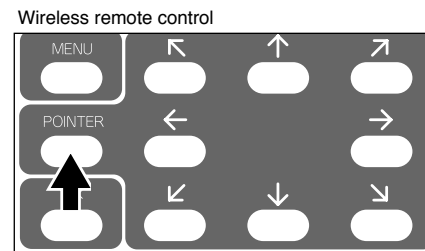

Mouse

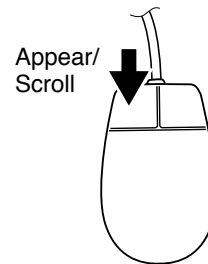

○ Pause

When the pause button **[PAUSE]** on the front operation panel or wireless remote control is pressed, the image of the main camera is stored in pause mode.

When the pause button **[PAUSE]** is pressed again, the pause mode is released.

Note: If the image is paused, the pause is released by switching the resolution or rotating the image. When the image is paused, Color/B&W switching is disabled.

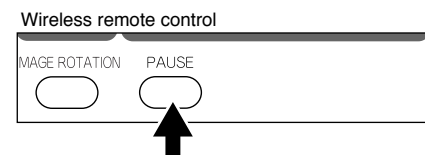
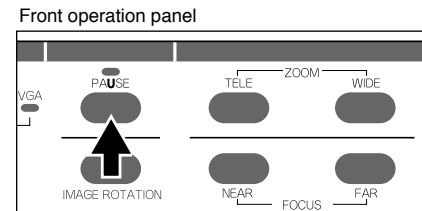

○ Enlarging the image

To double the image.

When the button **[2X]** on the front operation panel or wireless remote control is pressed or the right button of the mouse is clicked, the image is doubled, and at the same time, the scrolling (moving) pointer appears.

The screen is scrolled (moved) by using the direction buttons or by clicking and dragging the left button of the mouse. The screen can be scrolled within the shooting area of the built-in camera.

When the pointer is placed at the corner of the screen, the image is scrolled toward the corner.

The image can be enlarged only within the shooting area of the main camera.

Front operation panel

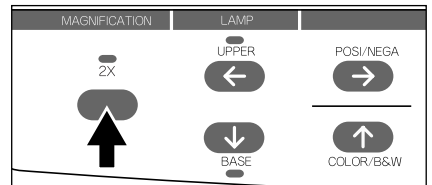

Wireless remote control

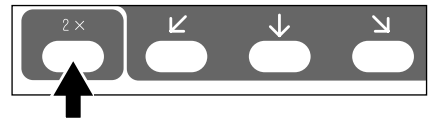

Mouse

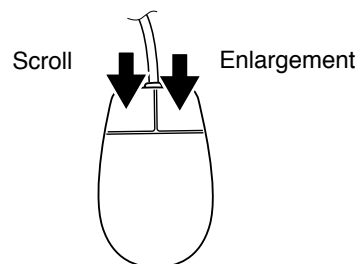

Front operation panel

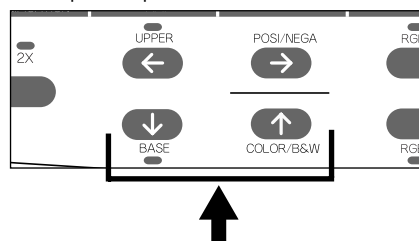

Wireless remote control

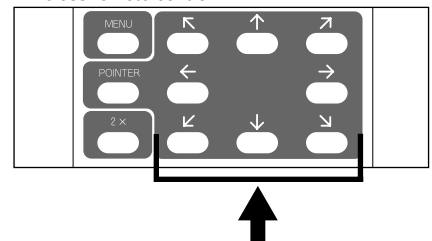

○ LCD monitor bracket socket

The LCD monitor bracket socket is used for attaching an LCD monitor (optional) with an LCD monitor bracket (optional). For the connection method and cables, refer to the instruction manual of the LCD monitor.

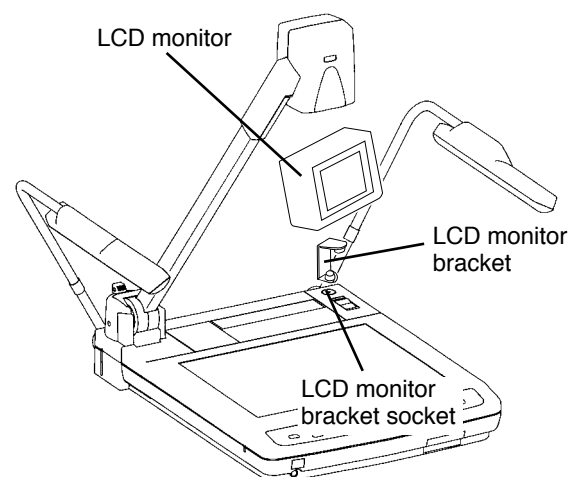

○ About the PC software "Image Mate for USB"

When the application [Image Mate for USB] is installed, the following operation are enabled:

- Image data transfer to the PC
- Operation of the Presenter by the PC

For further detail, refer to the installation manual for the application [Image Mate for USB] and the file [manual.pdf] in the CD-ROM.

Reference Page

· USB/RS-232C selection

P.30

7. OSD (On-Screen Display)

When the left button of the mouse is clicked or the menu button **[MENU]** on the remote control is pressed, the OSD menu and the pointer appear.

Each function item is set by using the mouse or the remote control buttons.

Mouse

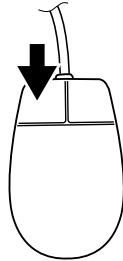

Wireless remote control

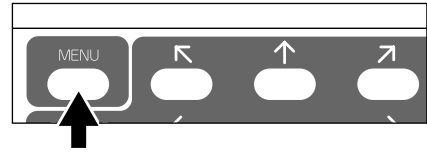

Use the following buttons on the Mouse for each function:

- **Left button**-----Each time the mouse is clicked, the pointer and the menu alternately appear and disappear.

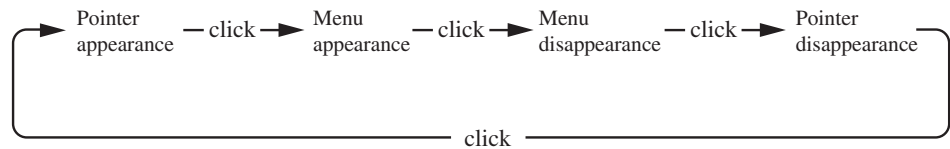

When the menu is in display, each item on the OSD menu is set.

During the electronic image magnification or image rotation (90° /270°), the image is scrolled by clicking and dragging the left button of the mouse.

Note: If the image is rotated by 90° or 270° without displaying the OSD, the scroll of the image (by clicking and dragging the left button of the mouse) is prioritized, and the OSD menu cannot be displayed by using the mouse.

- **Right button**-----When the right button of the mouse is clicked when the pointer is in display and, the image is electronically magnified centering round the position indicated by the pointer.

Note: When the mouse is clicked in the OSD menu, the menu functions are prioritized.

Use the following buttons on the Wireless Remote Control for each function:

- **[→] [→] [→] [→] [↗] [↘] [↙] [↖]**---Selection by using the pointer
- **[MENU]**-----For entry

When the menu button **[MENU]** is pressed again, the OSD menu disappears and only the pointer remains displayed.

For the information how to operate the pointer, refer to P.25.





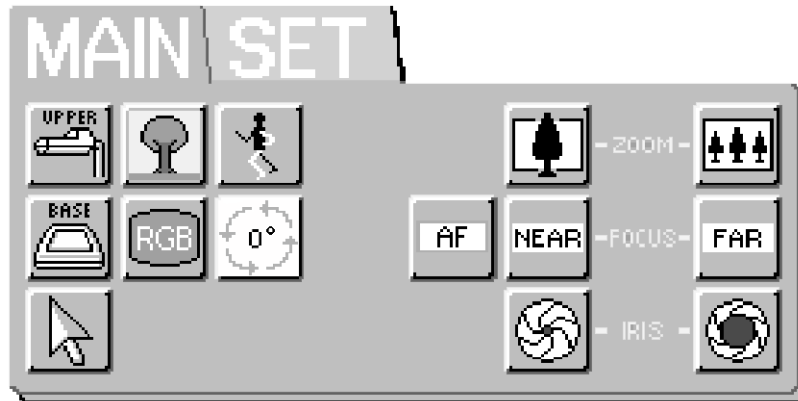

Note: The OSD is supposed to be used in a large projection size with a projector or the like.

If the OSD is used on an LCD monitor or a TV screen, the display may not be clearly seen.

○ Main menu

The main menu items can be set also from the front operation panel of the main body or the remote control.







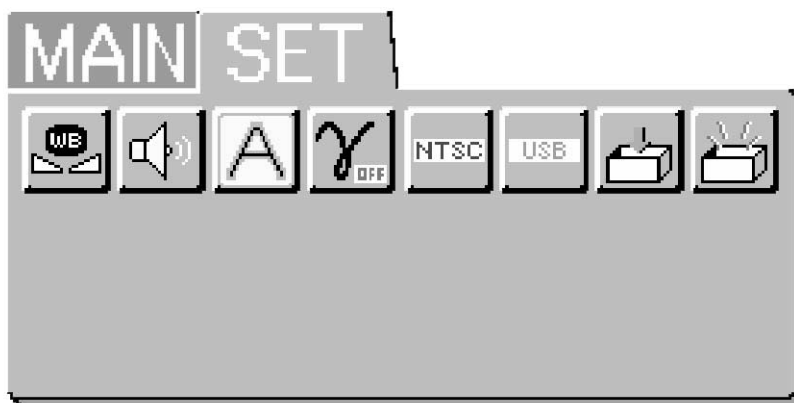

Icon	Name	Function
	Upper lighting unit ON/OFF	To turn ON/OFF the upper lighting unit. When the set menu is displayed for the first time, the previous setting is maintained. When this icon is clicked with the left button of the mouse, the lighting unit is switched.
	Base lighting unit ON/OFF	To turn ON/OFF the base lighting unit. When the set menu is displayed for the first time, the previous setting is maintained. When this icon is clicked with the left button of the mouse, the lighting unit is switched.
	Posi/Nega selection	To switch the posi/nega setting. When the main menu is displayed for the first time, the screen is in the posi setting. When this icon is clicked with the left button of the mouse, the icon changes and the posi setting is switched to the nega setting.
	Color/B&W selection	To switch the color/B&W setting. When the main menu is displayed for the first time, the screen is in the color setting. When this icon is clicked with the left button of the mouse, the icon changes and the color setting is switched to the B&W setting. Note: This function is not effective when the image is paused.
	Pause	To switch the Still/Moving setting. When the main menu is displayed for the first time, the screen is in the moving setting. When this icon is clicked with the left button of the mouse, the icon changes and the moving setting is switched to the still setting. Note: When the resolution change or the image rotation is performed in the pause mode, the pause mode is released.
	Image rotation	To rotate the image. When the main menu is displayed for the first time, the image rotation setting is 0°. Each time this icon is clicked with the left button of the mouse, the icon changes and the image rotates counterclockwise in the order of 90° → 180° → and 270°.
	Auto focus	The object is automatically brought in focus. When this icon is clicked with the left button of the mouse, the auto focus is activated. Note: The menu operation is disabled during the auto focus operation.

Icon	Name	Function
	Zoom TELE/WIDE	The image size is adjusted. When this icon is held down with the mouse, the zoom lens is activated.
	Focus NEAR/FAR	The focus is adjusted. When this icon is held down with the mouse, the focus is activated.
	Iris OPEN/CLOSE	The auto iris level under the lens is adjusted. When this icon is held down with the mouse, the lens iris is activated.
	Pointer	Used to change the pointer color in the screen. Each time this icon is clicked with the left button of the mouse, the icon pointer color changes in the order of white → blue → yellow → red, and the pointer color in the screen also changes in the order of white → blue → yellow → red.

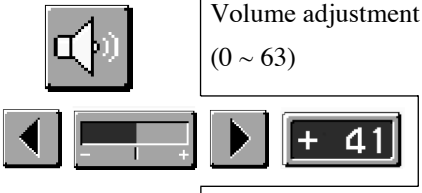
○ Set menu



Icon	Name	Function
	White balance	The white balance mode is switched among Auto/Manual/One-push. When the set menu is displayed for the first time, the white balance is in the auto mode. Note: In the one-push mode, the adjustment of <RED> and <BLUE> is disabled.
	Auto	To set the white balance in the automatic following mode (Initial setting).
 	Manual	To set the white balance by turning the knob <RED>/<BLUE>. Click the direction button beside the volume bar with the left button of the mouse to adjust the red and blue component. <RED>To adjust the red component. (-127~+127) <BLUE>To adjust the blue component. (-127~+127)
	One push	To set the push-set white balance. When the left button of the mouse is clicked, the white balance of the color temperature is fixed.

Icon	Name	Function
	Volume adjustment (0 ~ 63)	<p>The sound volume from the microphone jack is adjusted. When the set menu is displayed for the first time, the previous volume setting is maintained. When this icon is clicked with the left button of the mouse then, the volume bar appears. Click the direction buttons to adjust the sound volume with the left button of the mouse. When the volume adjustment icon is clicked with the left button of the mouse again, the volume bar disappears.</p> <p>The volume has been set to 41 before shipment.</p>
	Aperture selection	<p>The image enhancer (contour) is switched. When the set menu is displayed for the first time, the image enhancer is ON. When this icon is clicked with the left button of the mouse then, the icon changes to set the image enhancer to OFF.</p> <p>Note: This function is not effective for the NTSC/PAL monitor.</p>
	Gamma selection ON/OFF	<p>The gamma correction (1.0/0.6) is switched. When the set menu is displayed for the first time, the gamma correction setting is maintained.</p> <p>The gamma has been set to OFF (1.0) before shipment.</p>
	NTSC/PAL selection NTSC/PAL	<p>The down converter output type (NTSC/PAL) is switched. When the set menu is displayed for the first time, the down converter output type is maintained.</p> <p>The down converter output type has been set to NTSC before shipment.</p>
	USB/RS-232C selection USB/RS-232C	<p>The control mode for the main body from external equipment (USB jack/RS-232C jack) is switched. When the set menu is displayed for the first time, the control mode for the main body from external equipment is maintained.</p> <p>The control mode for the main body from external equipment has been set to USB before shipment.</p>
	Status saving	<p>The present status and adjusted values are saved. The status of lighting unit ON/OFF, resolution, gamma, NTSC/PAL, USB/RS-232C and the value of microphone volume, RED gain and BLUE gain are saved.</p>
	Initialization	<p>The adjusted values are reset to the values set before shipment. However, the current selections of the resolution, NTSC/PAL and USB/RS-232C remain unchanged.</p>

8. RS-232C SPECIFICATIONS

The Presenter can be controlled by a PC connected to the Presenter through the RS-232C terminal [RS-232C].

○ Setting up

- (1) Connect the Presenter to a PC with an RS-232C connection cable.

Note: When using an RS-232C cable available in the market, make sure of the connection shown in the page.

Note: To protect the Presenter and the PC, be sure to turn OFF all the power switches of all equipment before connecting.

- (2) Referring to P. 30, change the [USB] icon in the OSD menu to the [RS-232C] icon.

- (3) Start up the PC, and set the RS-232C baud rate (transmission rate) to 9600bps.

Note: For the information how to set the communication mode of the RS-232C, refer to the instruction manual of the PC.

- (4) Send the command to operate the Presenter from the PC (Refer to the list of communication commands).

- (5) Control through the RS-232C will start.

Note: For communication control, be sure to take the above steps for setting.

○ Cable connection

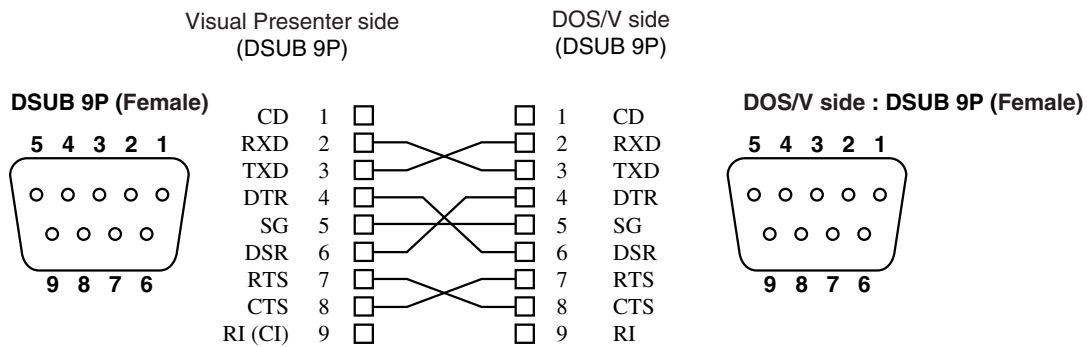

○ RS-232C connector specifications (DSUB 9P)

Pin No.	Code	Name	Direction of data		Comments
			Visual Presenter	PC	
1	CD	Carrier Detect	—	—	CD : Carrier Detect
2	RXD	Received Data	←	—	RXD : Received Data
3	TXD	Transmitted Data	—	→	TXD : Transmitted Data
4	DTR	Data Terminal Ready	—	→	DTR : Data Terminal Ready
5	SG	Signal Ground	—	—	SG : Signal Ground
6	DSR	Data Set Ready	←	—	DSR : Data Set Ready
7	RTS	Request To Send	—	→	RTS : Request To Send
8	CTS	Clear To Send	←	—	CTS : Clear To Send

○ Table of the communication commands

Function	Command	Parameter	Data	Comments
Auto Focus	AF	0	■ ■	Command to execute the one-step auto focus.
Focus adjustment	FO	+ (NEAR) - (FAR) 0 (STOP)	■ ■	Command to adjust the focus.
Zoom adjustment	ZO	+ (TELE) - (WIDE) 0 (STOP)	■ ■	Command to adjust the Zoom.
Iris adjustment	IR	+ (OPEN) - (CLOSE) 0 (STOP) 1 (AUTO)	■ ■	Command to adjust the Iris.
Lighting selection	PL	0 (OFF) 1 (BASE) 2 (UPPER)	■ ■	Command to select the Lighting.
Input selection	AV	0 (MAIN) 1 (RGB1) 2 (RGB2)	■ ■	Command to select the Input.
Posi/Nega conversion	NP	0 (POSI) 1 (NEGA)	■ ■	Command to convert Posi/Nega.
Color/B&W selection	CB	0 (COLOR) 1 (B&W)	■ ■	Command to select Color/B&W.
Pointer display	PO	0 (OFF) 1 (ON)	■ ■	Command to turn ON/OFF the Pointer display.
Enlarged image movement	PM	0 (STOP) 1 (→) 2 (←) 3 (↑) 4 (↓) 5 (↙) 6 (↗) 7 (↖) 8 (↘)	■ ■	<ul style="list-style-type: none"> • When the pointer is ON The pointer moves. • When the image enlargement is ON The enlarged image moves. <ul style="list-style-type: none"> 1: To the right side. 2: To the left side. 3: To the upper side. 4: To the lower side. 5: To the lower left. 6: To the upper right. 7: To the upper left. 8: To the lower right.
Electronic Magnification	MA	0 (OFF) 1 (ON)	■ ■	Command to enlarge the image to double the area around the pointer position.
Pause	FZ	0 (OFF) 1 (ON)	■ ■	Command to pause the image.
Local lockout	LL	0 (OFF) 1 (ON)	■ ■	Command to invalidate the switches on the front operation panel and wireless remote control.

Function	Command	Parameter	Data	Comments
Resolution selection	RS	0 (VGA) 1 (SVGA) 2 (XGA) 3 (SXGA)	■■	Command to switch the resolution.
Gamma selection	GM	0 (1.0) 1 (0.6)	■■	Command to switch the gamma setting value of the image.
Image rotation	RO	0 (OFF) 1 (90°) 2 (180°) 3 (270°)	■■	Command to rotate the image.
Aperture selection	AP	0 (OFF) 1 (ON)	■■	Command to switch the sharpness (edge effect) of the image.
Default	DF	0	■■	Command to reset to the initialized mode.
Status request	QS	0 2	■■	Command to inquire the status of the equipment.
ROM version	QR	0	■■	Command to refer to the ROM version.
Acknowledge check	SA	0 (OFF) 1 (ON)	■■	Command to select the command acknowledgement for each operation command.
Add CR command	SC	0 (OFF) 1 (ON)	■■	Command to add CR [0Dh] to the end of the acknowledge data Default is OFF.

Note: "■■" in the data column means that SPACE [20H] should be transmitted twice.

○ Data format specifications

This command is executed in the form of 1-command/1 packet. The next command is not accepted until the previous processing is completed.

- The communication command always starts with STX (Start of Text), and ends with ETX (End of Text).
- If the communication format or command name is wrong, NAK (Negative Acknowledgement) will be sent from the Presenter as a result of failing to receive correctly.
- When the communication format is correctly received, the Presenter sends ACK (Normal Acknowledgement).

● Transmission Command (PC → Visual Presenter)

Each operation command is executed in ASCII code, and transmitted in a set of 7 bytes as follows:

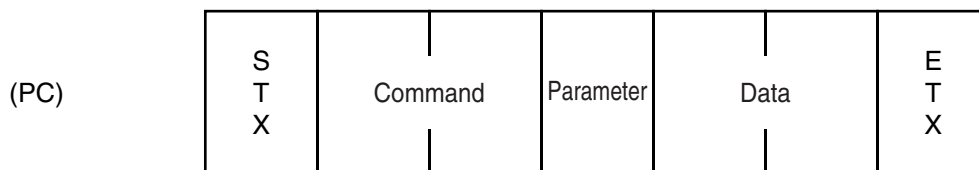

(Visual Presenter) → ACK

● **Response data format (Visual Presenter → PC)**

All response data are sent in the ASCII code in correspondence to the parameters in the list of operation commands.

· Status request format (Parameter 0)

S T X	Lighting selection	Input selection	Posi /Nega	Color /B&W	Pointer display	Electronic magnificant	Pause	Local Lock out	E T X
-------------	-----------------------	--------------------	---------------	---------------	--------------------	---------------------------	-------	-------------------	-------------

· Status request format (Parameter 2)

S T X	Resolution selection	Gamma selection	Image rotation	Aperture selection	30H	30H	30H	30H	E T X
-------------	-------------------------	--------------------	-------------------	-----------------------	-----	-----	-----	-----	-------------

· ROM version

S T X	V 56H	H 48H	C 43H	* * H	* * H	* * H	E T X
-------------	----------	----------	----------	-------	-------	-------	-------------

└── Version ──┘

○ **Transmission specifications**

- Full duplex start-stop sync. mode
- Start bit : 1 bit
- Data bit : 8 bit
- Stop bit : 1 bit
- Parity bit : None
- X parameter : None
- Baud rate (Communication speed) : 9600bps

○ **Connection**

If the RS-232C cable is not correctly connected between the Presenter and the PC, no acknowledgement is transmitted. Connect the RS-232C cable correctly, and fix it firmly with the connector set screws before the operation.

9. TROUBLESHOOTING HINTS

Symptom	Possible cause/countermeasure
No Images on TV monitor	<ul style="list-style-type: none"> • Cable is not properly connected to the video-in terminal of monitor. • The power cord is disconnected from the wall AC outlet. • The plug is disconnected from the power cord receptacle of the Presenter. • The power switch is not turned ON. • Zoom is set at TELE to display only white/black part of the material. • The switch is turned ON immediately after it is turned OFF. In this case, the Presenter may not start. Wait several seconds after turning OFF the power switch, and then turn ON the power switch.
Out of focus	<ul style="list-style-type: none"> • The object is too close to the lens. Check if it does not stand higher than 10cm above the stage surface. • Zoom is set at TELE after focusing at WIDE angle. Focus on the point of max. TELE. • In the auto-focus, focusing is difficult in some cases.
The lamp is not quickly turned ON	<ul style="list-style-type: none"> • For protection purposes, the lamp is turned ON after preheating for 2 seconds. This is not a fault.
Image is too dark	<ul style="list-style-type: none"> • The ambient light is not sufficient. Press the upper lighting unit button [UPPER] to turn ON the upper lamp.
Moire pattern appears on the screen image	<ul style="list-style-type: none"> • This is caused by the interference fringe between the meshed pattern of the object and the CCD elements. This is normal. This may be reduced by changing the projecting range. • Vertical stripes may appear on the liquid crystal projector screen. This can be reduced by manually adjusting the dot clock frequency on the projector side. (Refer to P.13)
Brightness tone is off the setting	<ul style="list-style-type: none"> • This may be reduced by switching the gamma setting.

If the trouble still remains after checking the above, consult your dealer or an authorized ELMO service center.

10. SPECIFICATIONS

● General

Item	Specifications		
Power source	AC120V 60Hz		
Power consumption	45W		
AC outlet	1 pce. (Max. 400W/Unswitched)		
DC output terminal	DC12V (Max. 0.9A)		
Outside dimensions	400mm(W) X 655mm(D) X 187mm(H) (15.7 X 25.8 X 7.4 in.) - When folded 700mm(W) X 542mm(D) X 615mm(H) (27.6 X 21.3 X 24.2 in.) - When set up		
Weight	10 kgs (22.1 lbs) (main body only)		
Input selection	Internal/RGB1/RGB2		
Output terminal	RGB output	DSUB 15P connector female	1
	Composite-video output	RCA pinjack/75Ω unbalanced (NTSC/PAL)	1
	S-video output	Mini DIN 4P connector/75Ω unbalanced (NTSC/PAL)	1
	Audio output (stereo)	RCA pinjack/applicable impedance 10kΩ or more, -10dB	1 pair
Input terminal	RGB input	DSUB 15P connector female	2
	Audio input (stereo)	500mV(rms) impedance 47kΩ or more, φ 3.5mm stereo mini jack	2
	Mic. input (Monaural)	φ 6.3mm jack/applicable impedance 600Ω-65dB	1
Ext. control terminal	RS-232C	DSUB 9P connector male	1
	Mouse	DSUB 9P connector male	1
	USB	Type B receptacle	1

● Camera

Item	Specifications
Lens	f=7.2~72mm(10-time zoom) F2.8
Shooting speed	7.5 frames / sec
Shooting area	362mm x 290mm (14.3 X 11.4 in.) max., 40mm x 32mm (1.5 X 1.2 in.) min.
Limit of focus adjustment	At the range of stage surface~100mm from the stage surface
Zoom	Powered (with double speed function)
Focusing	Auto/manual
Iris	Auto (with level adjustment)/manual
Image pick-up element	1/2" CCD
Total picture elements	1434(H) x 1050(V) (approx. 1,500,000 pixels)
Effective picture element	1280 (H) x 1024(V)
Sync. system	Internal
Resolution	Analog RGB output More than 800 TV lines (horizontal) More than 800 TV lines (Vertical) (for output in SXGA) Video output More than 400 TV lines (horizontal)
Analog RGB output	Signal frequency Horizontal frequency : Vertical frequency SXGA 79.976kHz : 75.025kHz VESA conformable (1280 x 1024@75Hz) XGA 60.023kHz : 75.029kHz (1024 x 768@75Hz) SVGA 46.875kHz : 75.000kHz (800 x 600@75Hz) VGA 37.500kHz : 75.000kHz (640 x 480@75Hz)
Composite-video output	NTSC/PAL conformable
S-video output	NTSC/PAL conformable
White balance	Full auto/One push/Manual
Posi/Nega conversion	Provided
Color/B&W selection	Provided
Image rotation	Provided
Resolution selection	Provided (SXGA→XGA→SVGA→VGA)
Gamma adjustment	Provided (1.0/0.6)
Aperture selection	Provided
Video output selection	Provided (NTSC/PAL)
Pause mode	Provided
Enlargement of the image	Provided (double, can be scrolled)
Pointer	Controllable with wireless remote control and nouse (Color selectable)

● Lighting

Item	Specifications
Upper	High frequency lighting mode, 3-wave-length type fluorescent lamp 6W (Type:FHL6EX-N)
Base	High frequency lighting mode, 3-wave-length type fluorescent lamp Area size: 296mm(W) x 216mm(H) 11.65in(W) x 8.50in(H)

● Supplied accessories

Name	Quantity
Power cord	1
DC cable	1
Video-audio cable	1
Mini DIN 4P (S-video) cable	1
Mouse	1
Infrared wireless remote control (RCW-802)	1
Batteries (Type R03, AAA)	2
Analog RGB cable (BNC connector)	1
VGA cable (DSUB 15P connector)	1
PC link software "Image Mate for USB" CD-ROM	1
USB cable	1
Stickers of toplights	4
Instruction manual	1

● Options

- LCD monitor bracket

Note: The specifications are subject to change without notice.
Dimensions and weight are approximate.

Trademark Acknowledgements

VESA is a registered trademark of Video Electronics Standards Association.

ELMO, VISUAL PRESENTER/Visual Presenter, FOCUSFREE, Image Mate are registered trademarks of Elmo Co., Ltd.

WARNING:

- Unauthorized recording of copyrighted slide films, materials, photographs, etc. may infringe on the rights of copyright owners and be contrary to copyright laws.



ELMO CO., LTD.

6-14, Meizen-cho, Mizuho-ku,
Nagoya, 467-8567, Japan

OVERSEAS SUBSIDIARY COMPANIES

- | | |
|----------------|---|
| U.S.A. | Elmo Mfg. Corp.
1478 Old Country Road, Plainview, NY 11803-5034
Tel : (516)501-1400 Fax : (516)501-0429
E-mail : elmo@elmousa.com
web : http://www.elmousa.com/ |
| Canada | Elmo Canada Mfg. Corp.
44 West Drive, Brampton, Ontario L6T 3T6
Tel : (905)453-7880 Fax : (905)453-2391
E-mail : info@elmocanada.com
Web : http://www.elmocanada.com/ |
| Germany | Elmo (Europe) G.m.b.H
Neanderstr. 18, 40233 Düsseldorf
Tel : (0211)376051 Fax : (0211)376630
E-mail : elmoeurope@AOL.com
web : http://www.elmo.de/ |